

10211

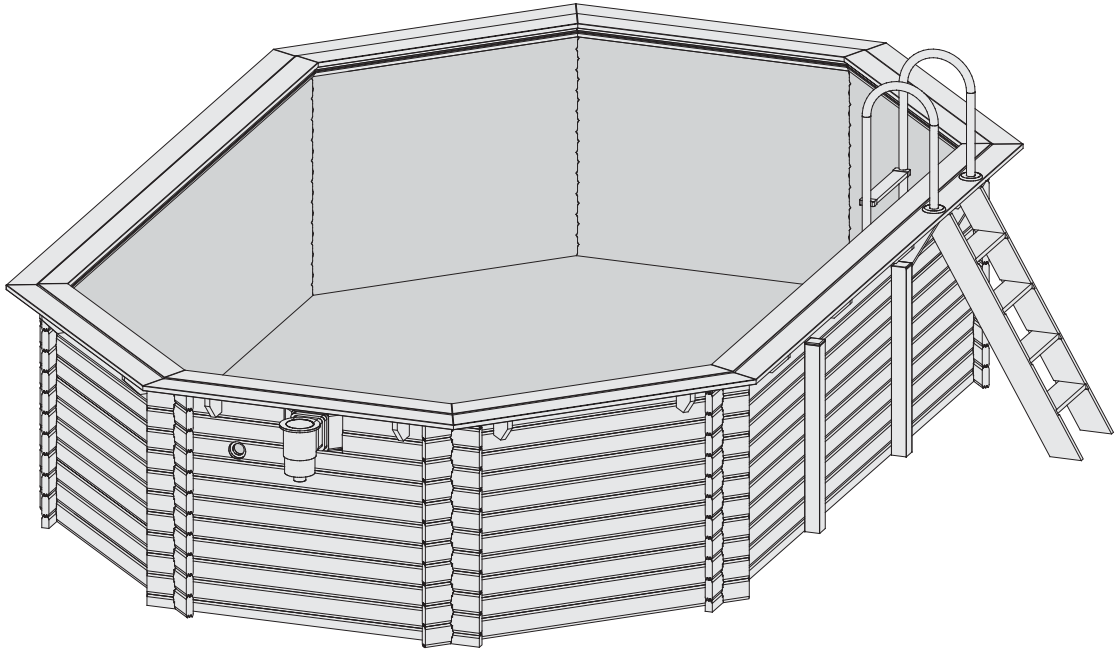

-  **Aufbauanleitung**
-  **Building Instructions**
-  **notice de montage**
-  **montagehandleiding**
-  **Montagevejledning**
-  **Instrucciones de construcción**
-  **Istruzioni per il montaggio**
-  **Montážní návod**

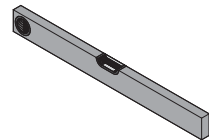

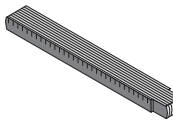
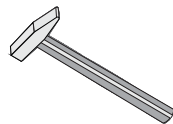
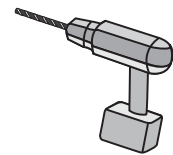
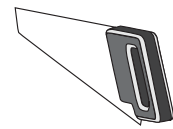

Vergleichen Sie zuerst die Material-liste mit Ihrem Paketinhalt! Bitte haben Sie Verständnis, dass Beanstandungen nur im nicht aufgebauten Zustand bearbeitet werden können!



Vergelijk eerst de lijst van materialen met de inhoud van uw pakket! Reclamaties kunnen alleen in behandeling worden genomen zolang de onderdelen nog niet zijn gemonteerd!



Confrontate questa distinta materiali prima con il contenuto del pacchetto! Vi preghiamo di comprendere che eventuali reclami possono essere accolti solo prima del montaggio!



First compare the list of materials with your package contents! Please understand that complaints can be processed in the non-built status only!



Start med at kontrollere materialelisten med indholdet af den leverede pakke! Vi gør venligst opmærksom på at reklamationer kun kan behandles for materialer som ikke er blevet bearbejdet!



Nejprve přezkontrolujte obsah balení podle materiálového listu! Mějte pochopení pro to, že případnou reklamaci se můžeme zabývat pouze tehdy, když díly nebudou smontované! Za pomoci tohoto seznamu můžete jednotlivé díly přiřadit k montážnímu návodu.



Commencez par comparer la liste du matériel avec le contenu de votre paquet! Sachez que nous traitons uniquement les réclamations concernant le matériel à l'état non monté!



En primer lugar, compare la lista de material con el contenido del paquete. Rogamos entienda que las reclamaciones sólo pueden ser tramitadas antes de montar el objeto!

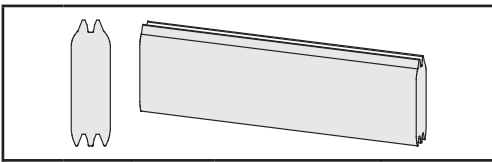
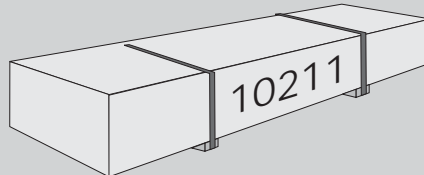

1 x A1 | 304 x 121 x 38 mm | ID 39808

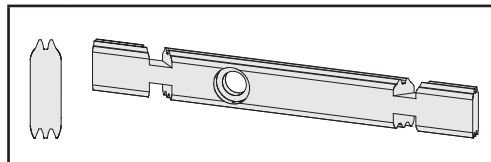

1 x W9 | 1773 x 121 x 38 mm | ID 39342

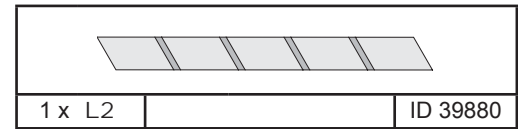

1 x L2 | ID 39880

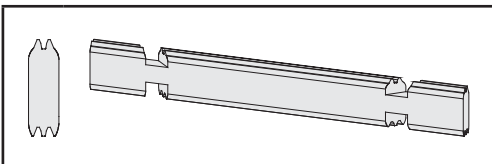

61 x W1 | 1773 x 121 x 38 mm | ID 39276

20 x W2 | 3883 x 121 x 38 mm | ID 39345

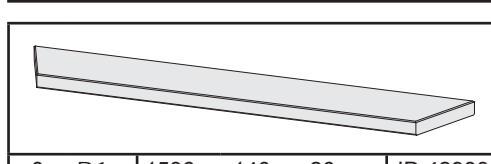

6 x B1 | 1536 x 140 x 26 mm | ID 42933

6 x B2 | 1656 x 140 x 26 mm | ID 42939

2 x B3 | 3646 x 140 x 26 mm | ID 42936

2 x B4 | 3767 x 140 x 26 mm | ID 42941

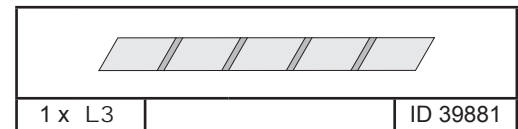

1 x L3 | ID 39881

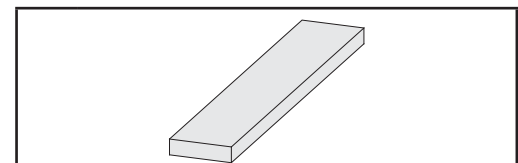

4 x L4 | ID 39883

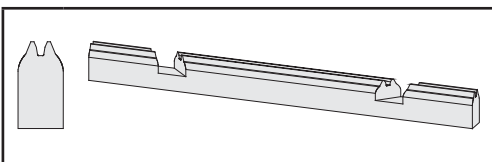

2 x W3 | 1773 x 71 x 38 mm | ID 39365

2 x W4 | 3883 x 71 x 38 mm | ID 39368

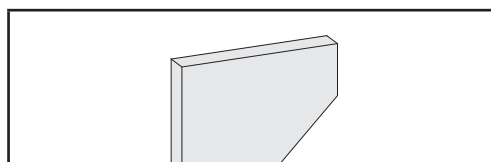

20 x M1 | 170 x 140 x 26 mm | ID 42932

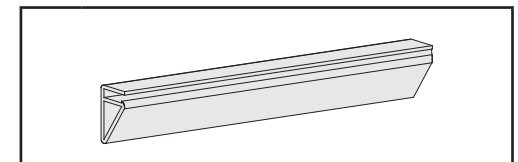

10 x D1 | 1950 x 33 x 17 mm | ID 24431

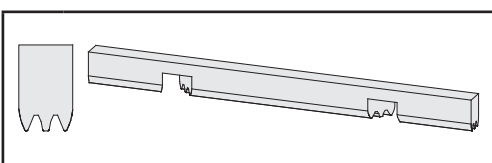

2 x W5 | 1773 x 60 x 38 mm | ID 39286

2 x W6 | 3883 x 60 x 38 mm | ID 39346

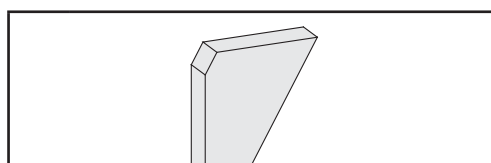

2 x M2 | 346 x 200 x 55 mm | ID 72767

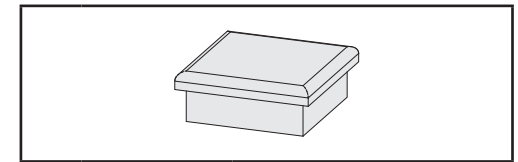

4 x R1 | ID 10224

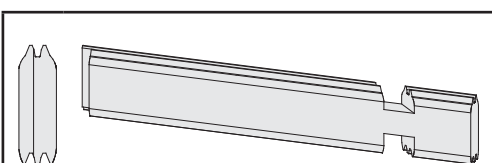

2 x W7 | 731 x 121 x 38 mm | ID 39311

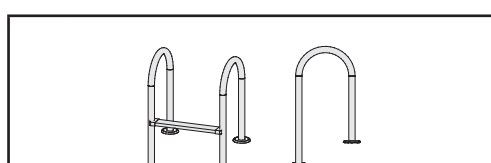

1 x L1 | ID 39258

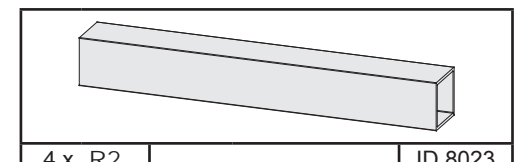

4 x R2 | ID 8023

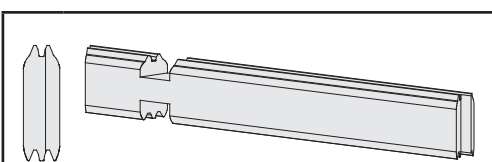

2 x W8 | 731 x 121 x 38 mm | ID 39315

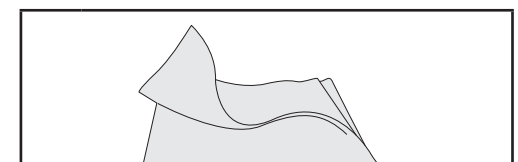

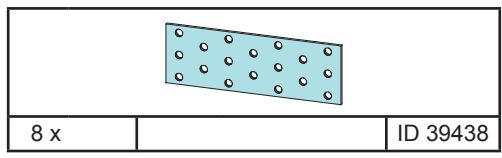
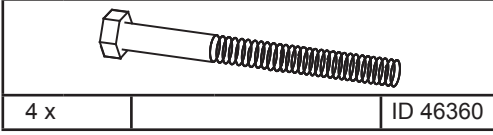
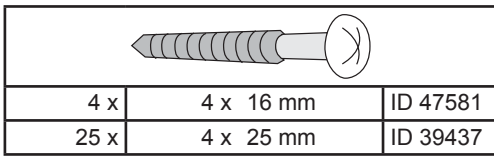
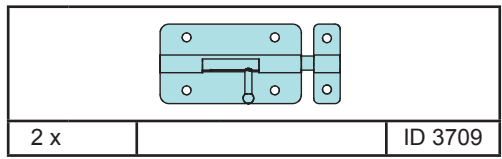
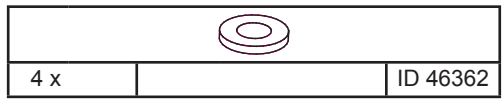
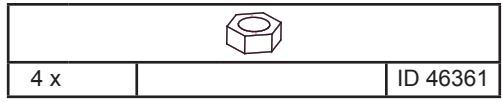
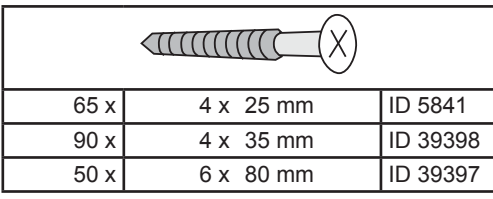
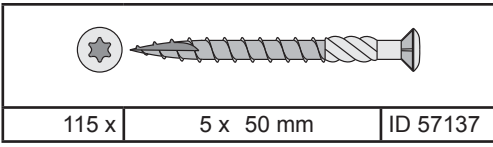
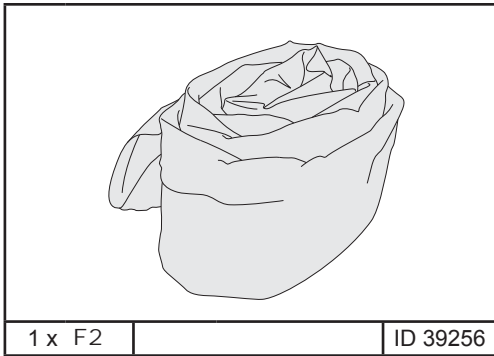

1 x F1 | ID 39260



-  Übersicht
-  Overview
-  enquête



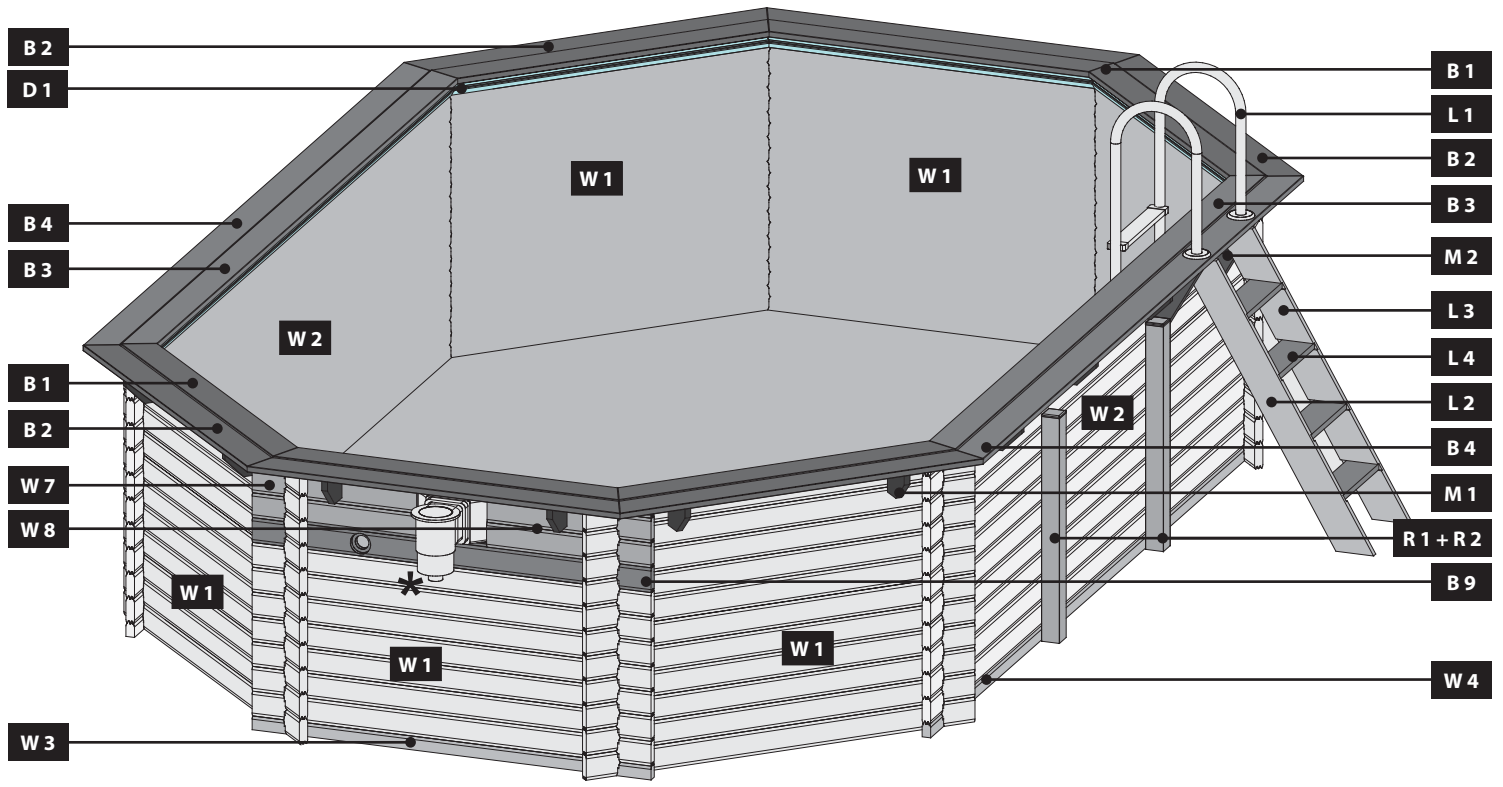

-  overzicht
-  undersøgelse
-  estudio





-  sondaggio
-  přehled











 Bitte bewahren Sie die Anleitung und den Garantieschein zur Seriennummer auf. Vernichten Sie diese erst nach Ablauf der Garantiezeit. Eventuelle Beanstandungen können mithilfe der Stückliste einfacher zugeordnet werden.

Beigelegte Dokumente:
• Informationsheft
• Garantieschein zur Seriennummer
• ggf. Zubehör-Anleitungen in externen Paketen

- *  Nicht im Lieferumfang enthalten
 Not included
 Non comprises dans la livraison
 Niet bijgeleverd



-  No forman parte del suministro
 Non incluso
 V ceně není zahrnuto
 Ikke inkluderet

- 1  Länge muss ermittelt und zugesägt werden
 Length must be determined and sawn
 La longueur doit être déterminée et sciée
 De lengte moet worden bepaald en worden gezaagd

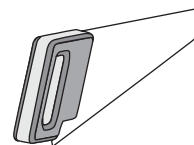
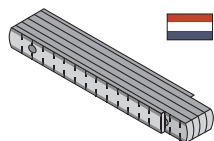
-  La longitud debe ser determinada y aserrada
 La lunghezza deve essere determinata e segata
 Délka musí být určena a rozřezána
 Længden skal bestemmes og saves



- 2  Nicht gebraucht
 Not needed
 Pas nécessaire
 Niet nodig



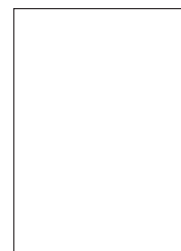

-  No es necesario
 Non necessario
 Není nutná

- 3  mit Zubehör!
 met toebehoren!
 with accessories!
 avec accessoires!

-  con accesorios!
 con accessori!
 s příslušenstvím!
 z dodatki!





- 4  Fixiert vorübergehend
 tijdelijk vast
 Fixed temporarily
 temporairement fixe

-  temporalmente fijo
 temporaneamente fisso
 dočasně pevný
 Začasno pritrjeno

 Um das Ertrinken von Kindern zu verhindern, wird empfohlen, den Zugang zum Schwimmbecken mit einer Schutzvorrichtung zu sichern!

 For at forhindre drukning af børn anbefales det at sikre adgang til swimmingpoolen med en beskyttelsesordning!

 To prevent the drowning of children, it is recommended to secure access to the swimming pool with a protective device!

 Para evitar que los niños se ahoguen, se recomienda asegurar el acceso a la piscina con un dispositivo de protección.









 Pour éviter la noyade des enfants, il est recommandé de sécuriser l'accès à la piscine avec un dispositif de protection!

 Per prevenire l'annegamento dei bambini, si consiglia di proteggere l'accesso alla piscina con un dispositivo di protezione!

 Om verdrinking van kinderen te voorkomen, is het aan te raden om de toegang tot het zwembad te beveiligen met een beschermend apparaat!

 Aby se zabránilo utopení dětí, doporučuje se zajistit přístup k bazénu s ochranným zařízením!



-  Skimmer in Hauptwindrichtung einbauen
-  installeren skimmers in de belangrijkste windrichting
-  installing skimmers in the main wind direction
-  l'installation de récupérateurs dans la direction principale du vent
-  la instalación de skimmers en la dirección dominante del viento
-  installazione skimmer nella direzione principale del vento
-  instalaci sběračky v hlavním směru větru
-  Installer skimmer i hovedvindretningen

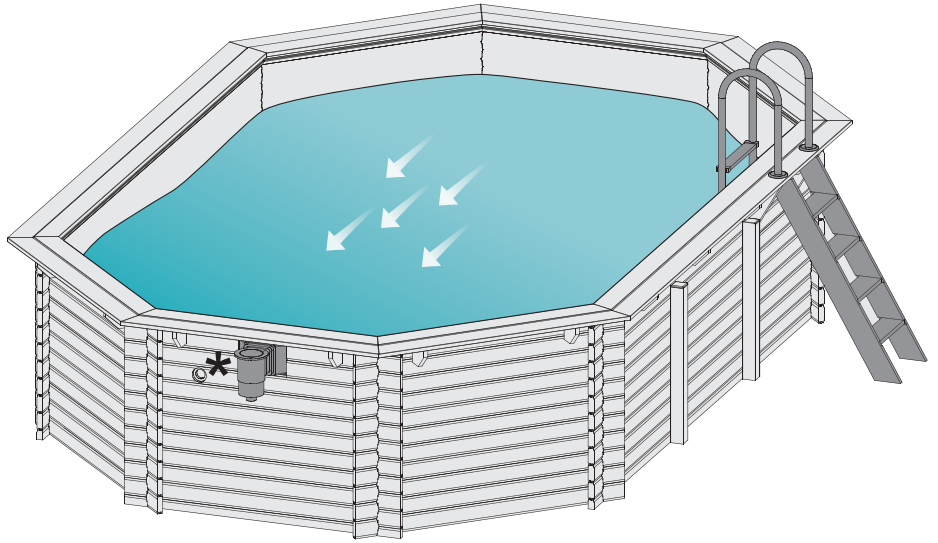
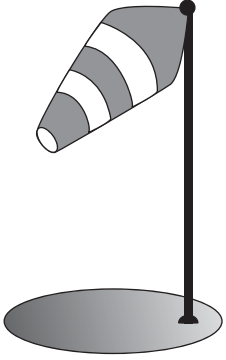

01

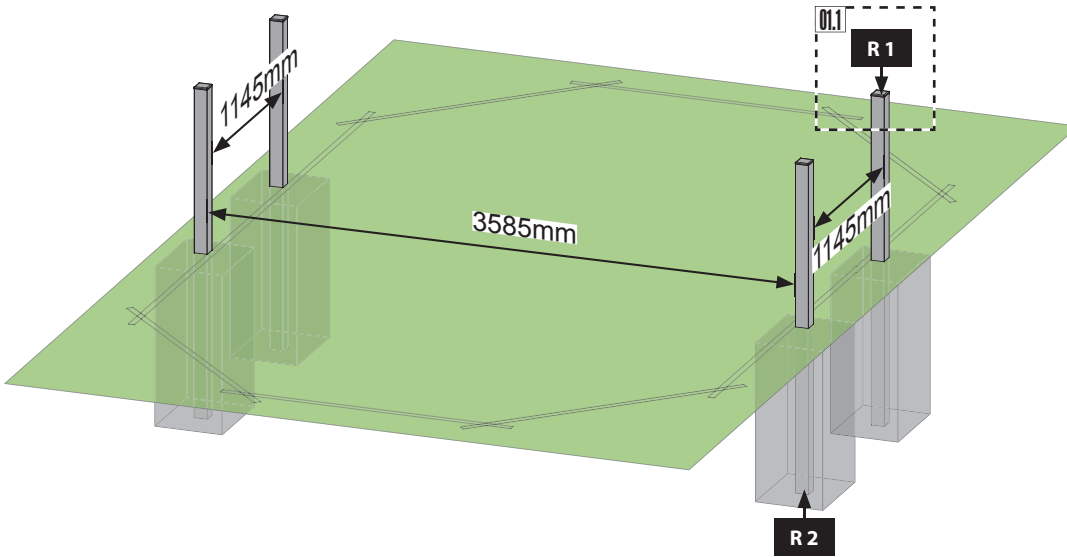

01.1

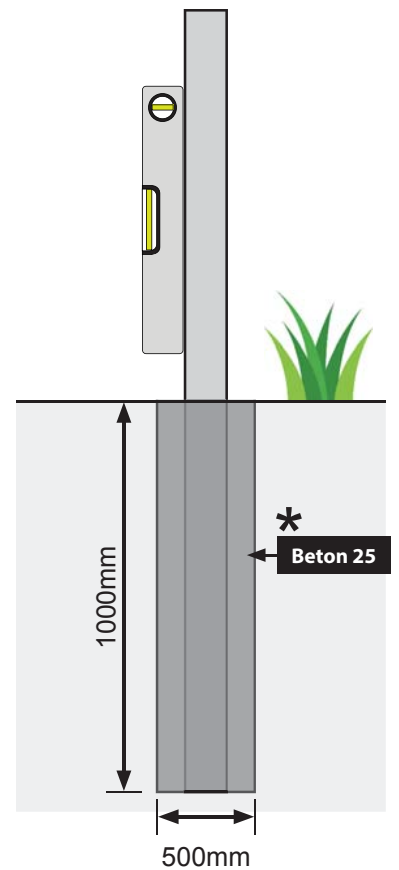
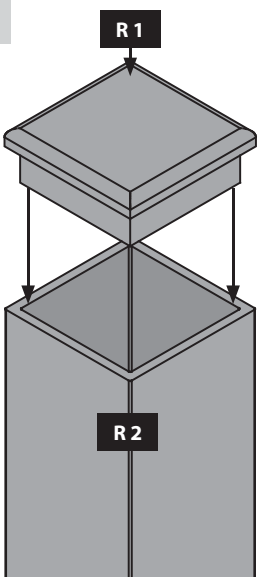

02

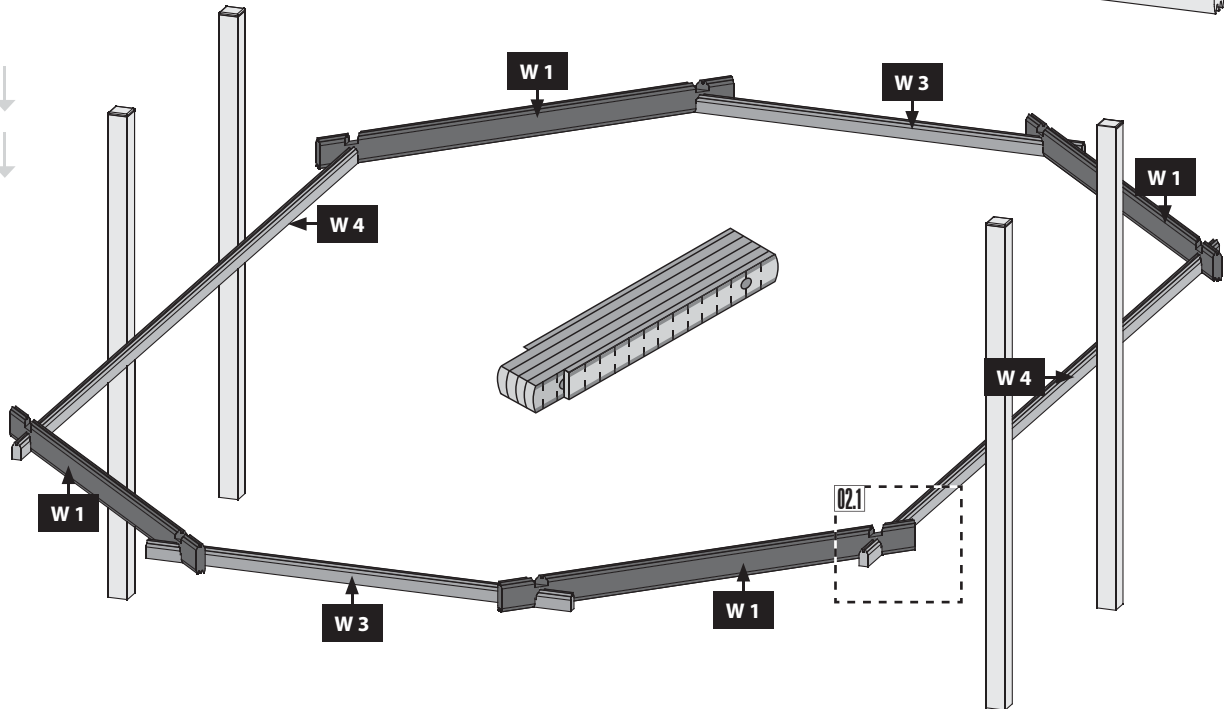
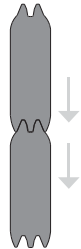
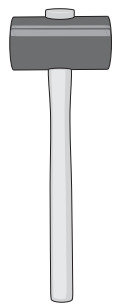
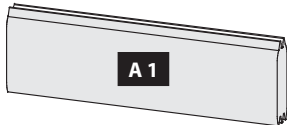

02.1-1

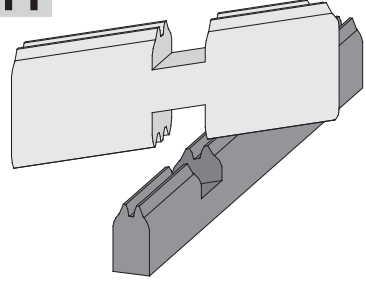

02.1-2

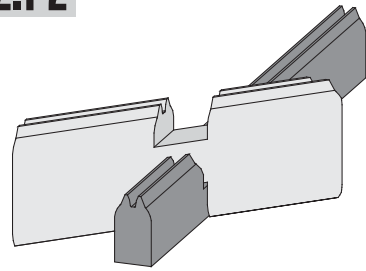

02.1-3

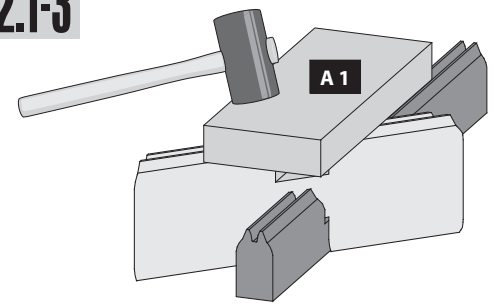

03

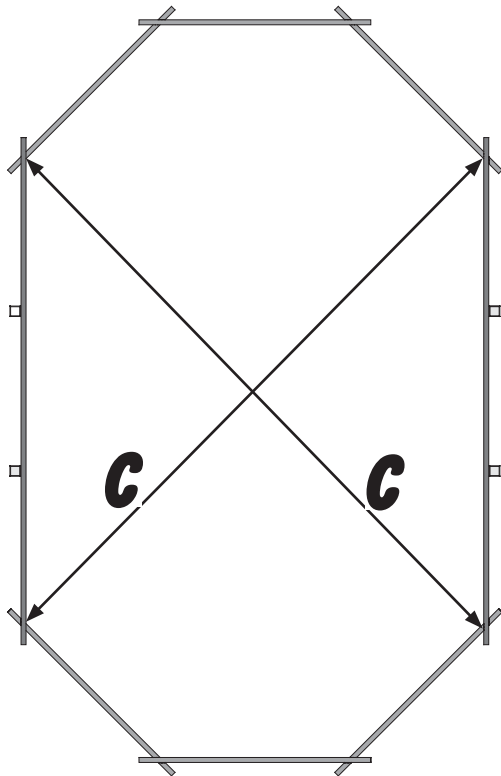
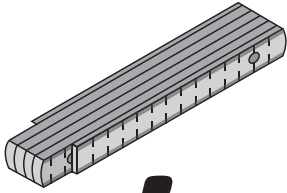
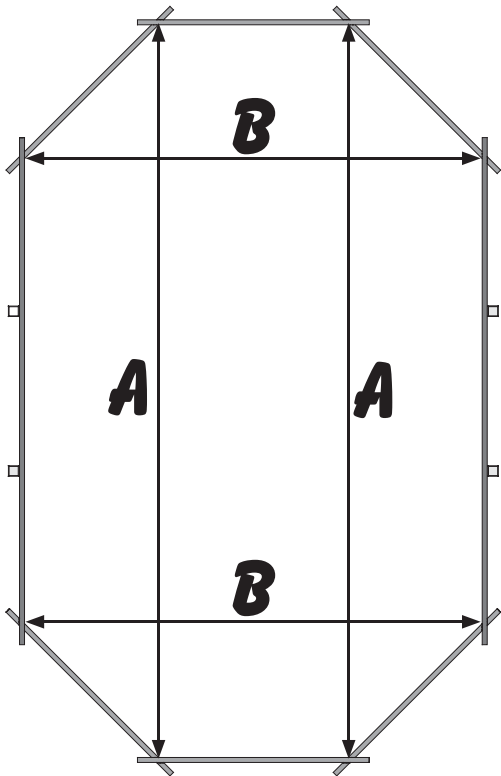

04

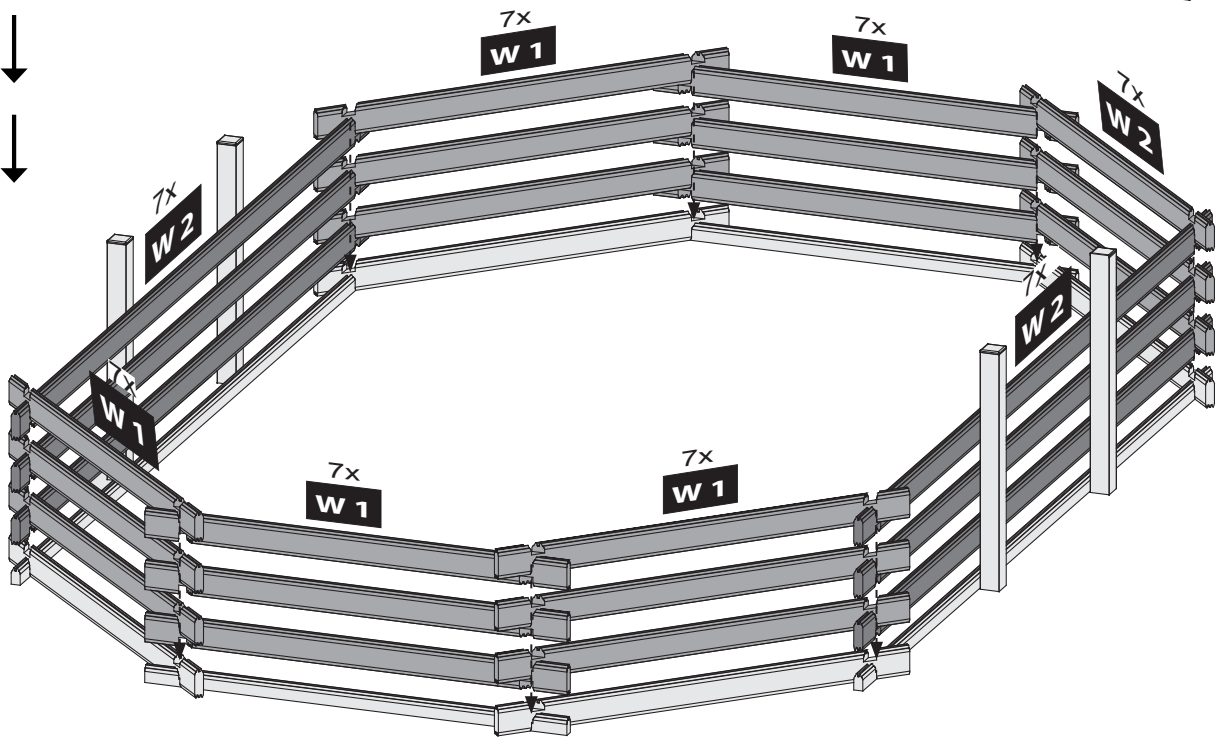
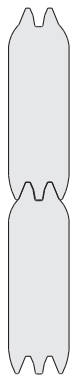

05

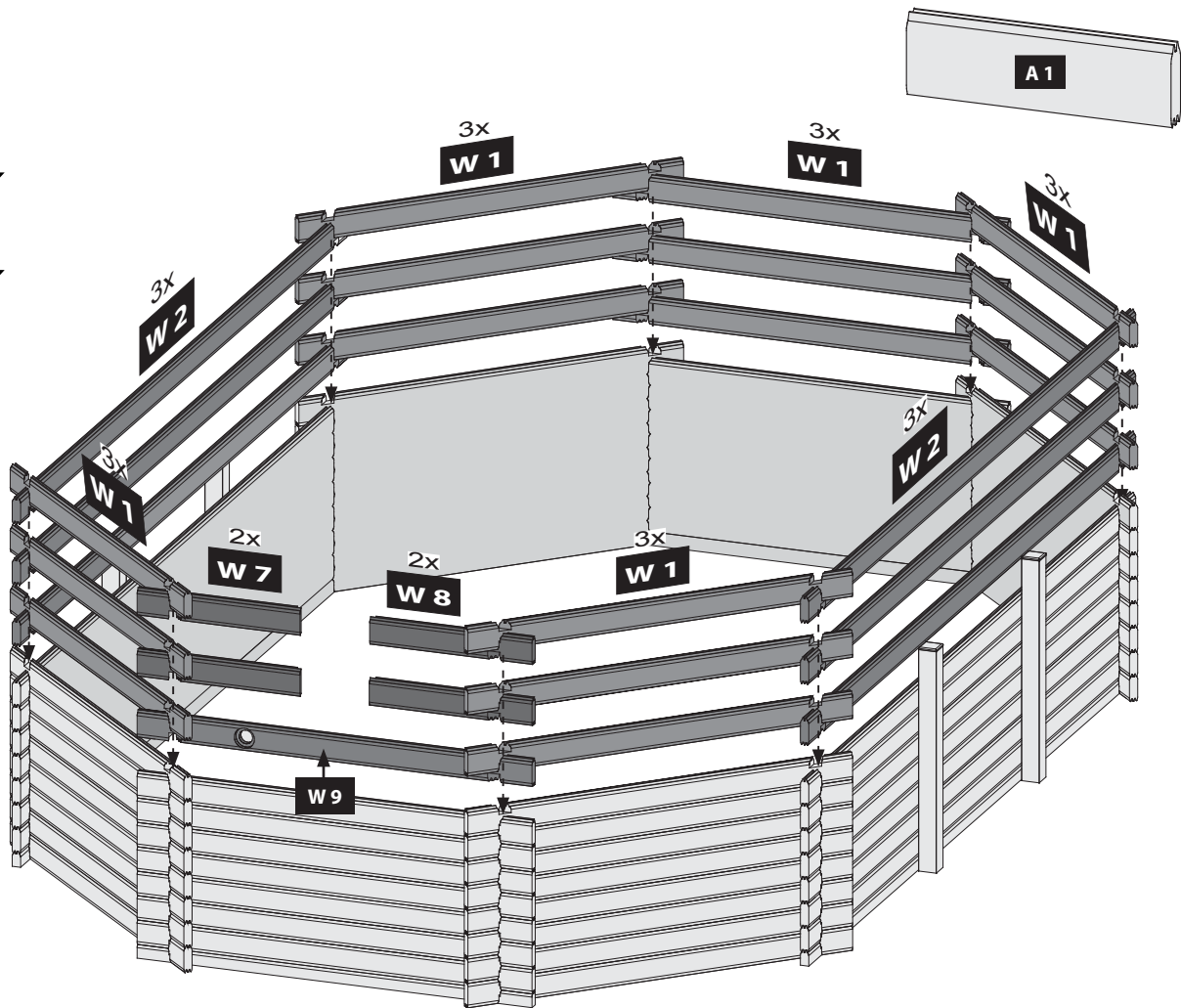
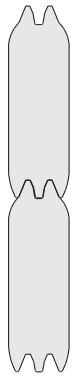

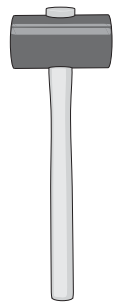
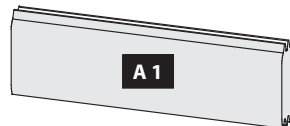

-  Bündig!
-  Flush!
-  Affleurement!
-  Gelijk!
-  I flugt!
-  Aras!
-  Combacia!
-  Stejný!

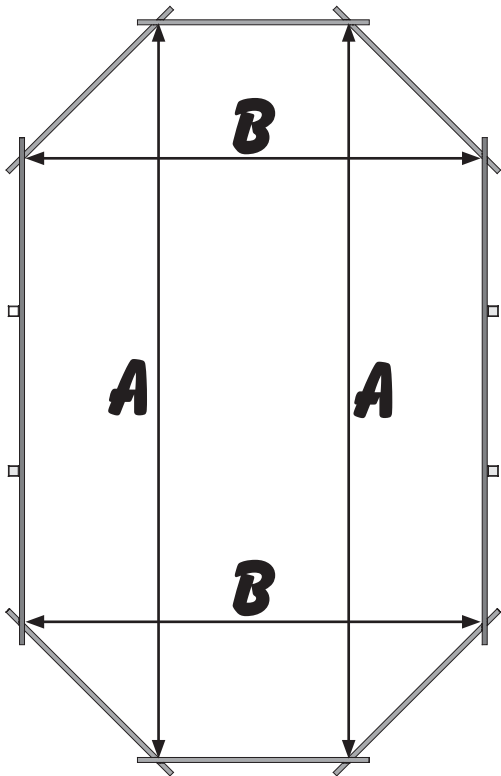
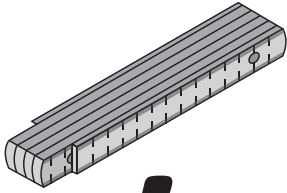
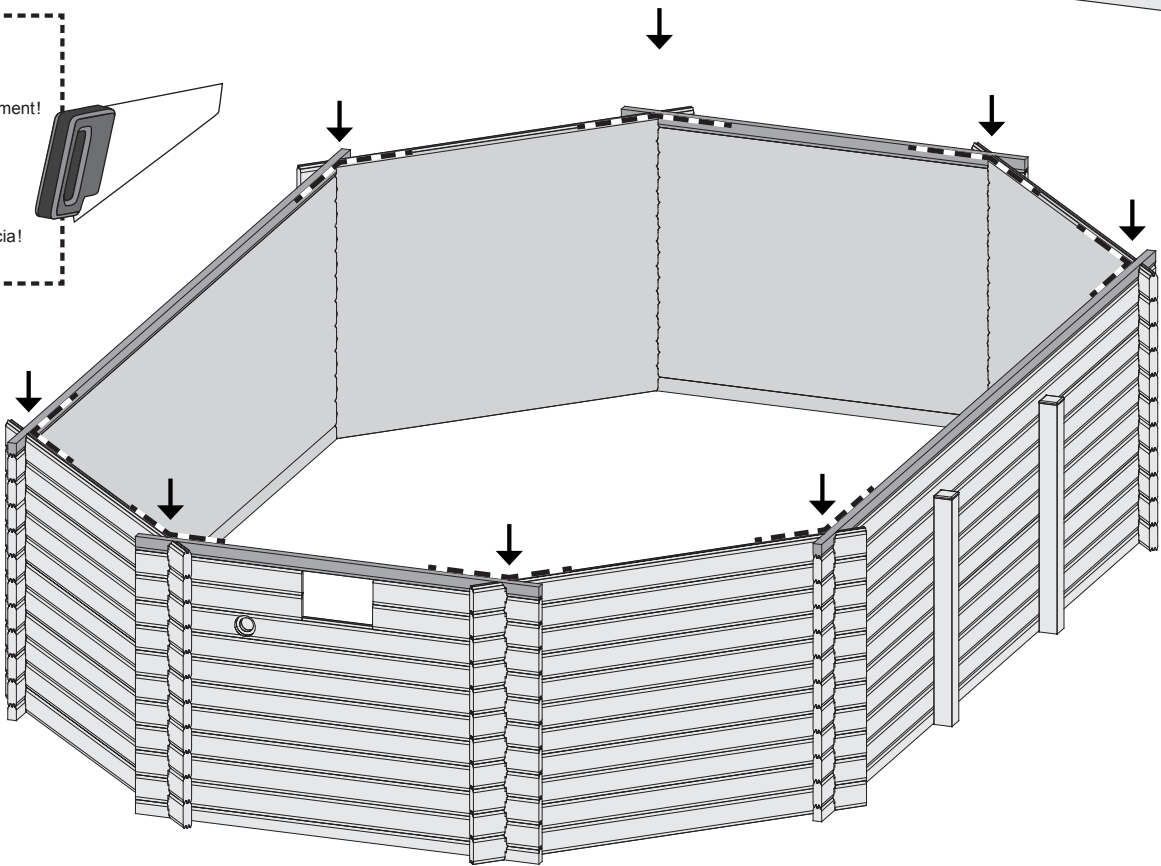
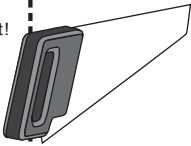

!

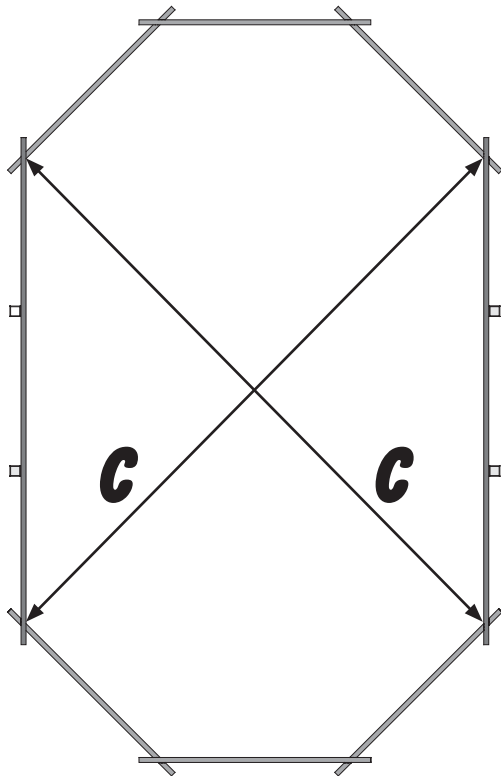

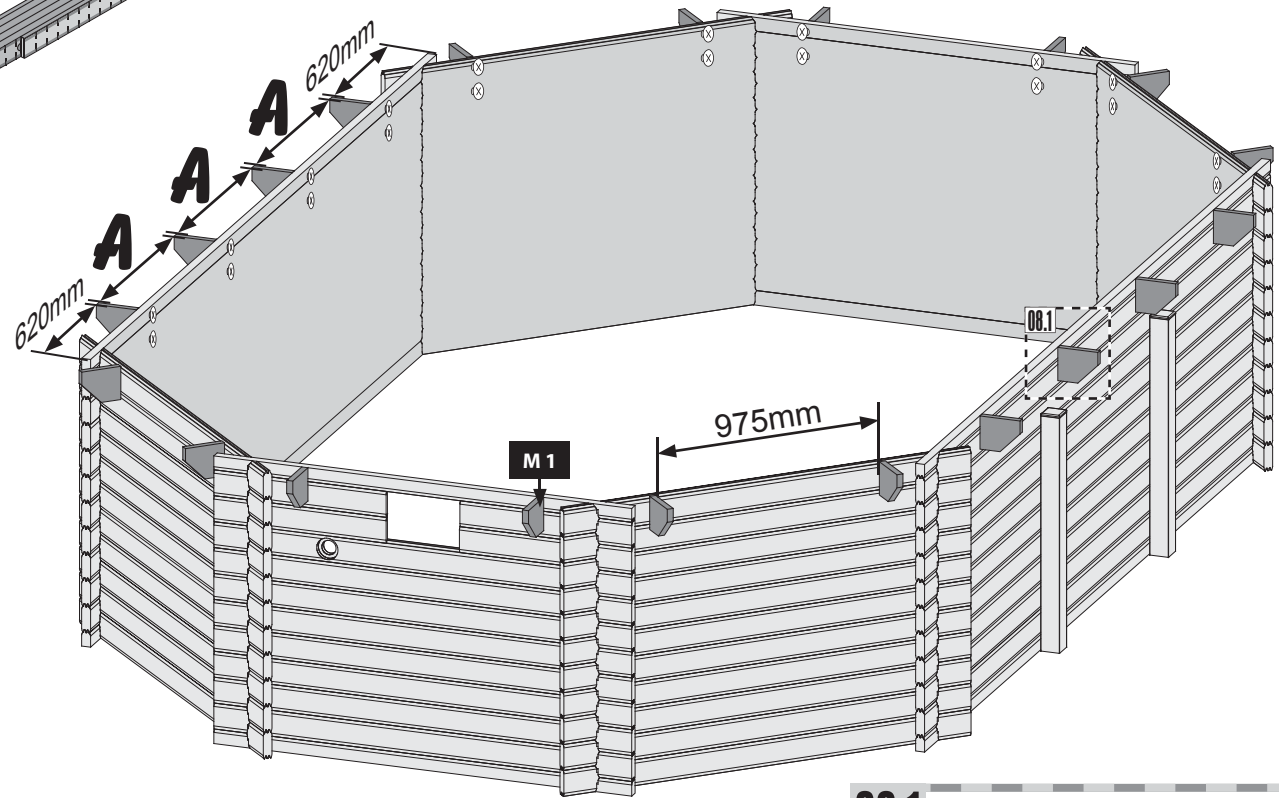
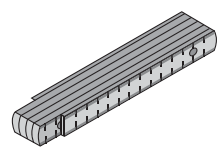



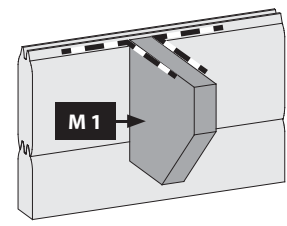





08.1



-  Bündig!
-  Flush!
-  Affleurement!
-  Gelijk!
-  I flugt!
-  Aras!
-  Combacia!
-  Stejný!

-  Wählen Sie die Position der Leiter
-  Selecteer de positie van de trap
-  Select the position of the stairs
-  Sélectionnez la position de l'escalier
-  Seleccione la posición de la escalera
-  Selezionare la posizione delle scale
-  Zvolte pozici schodiště
-  Vælg positionen af stigen

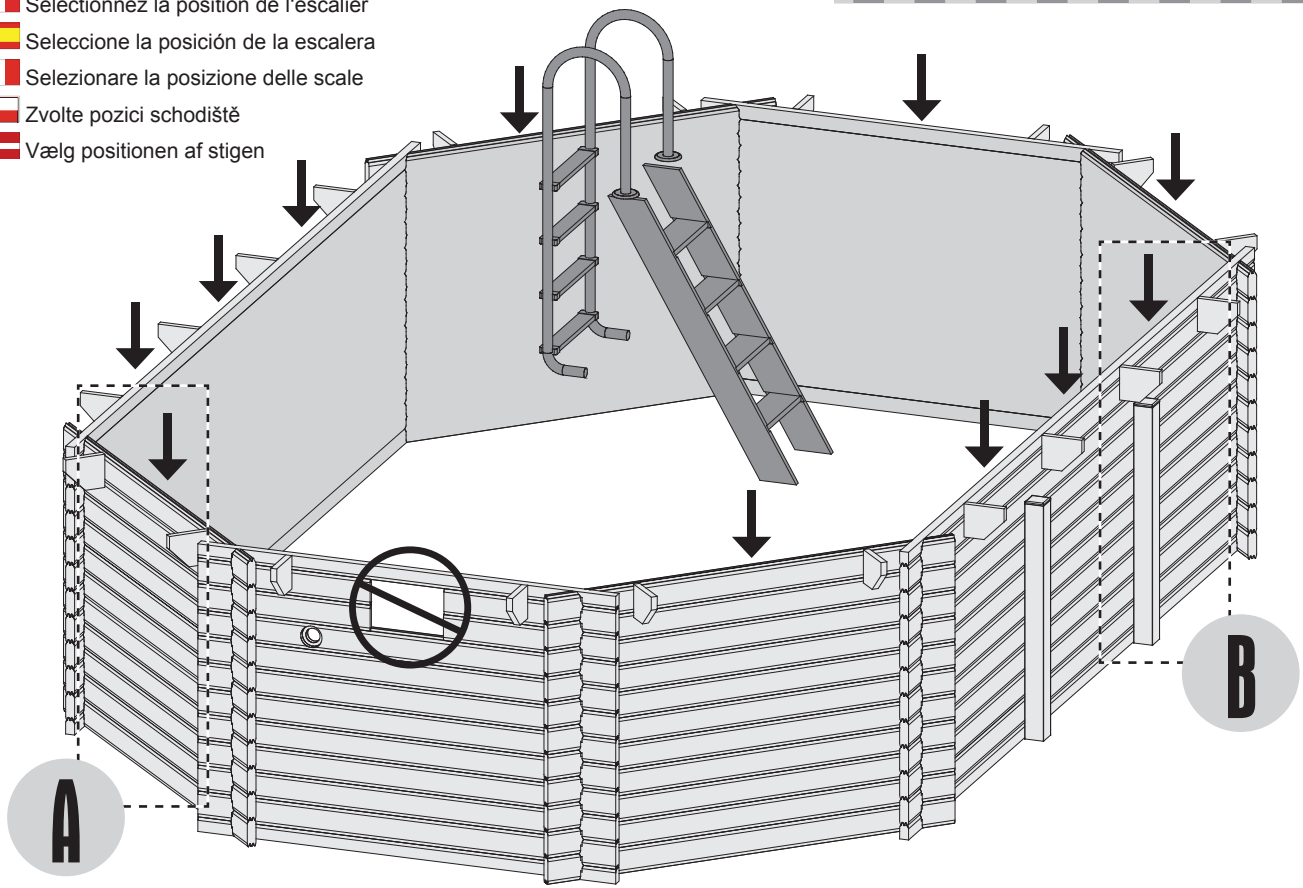

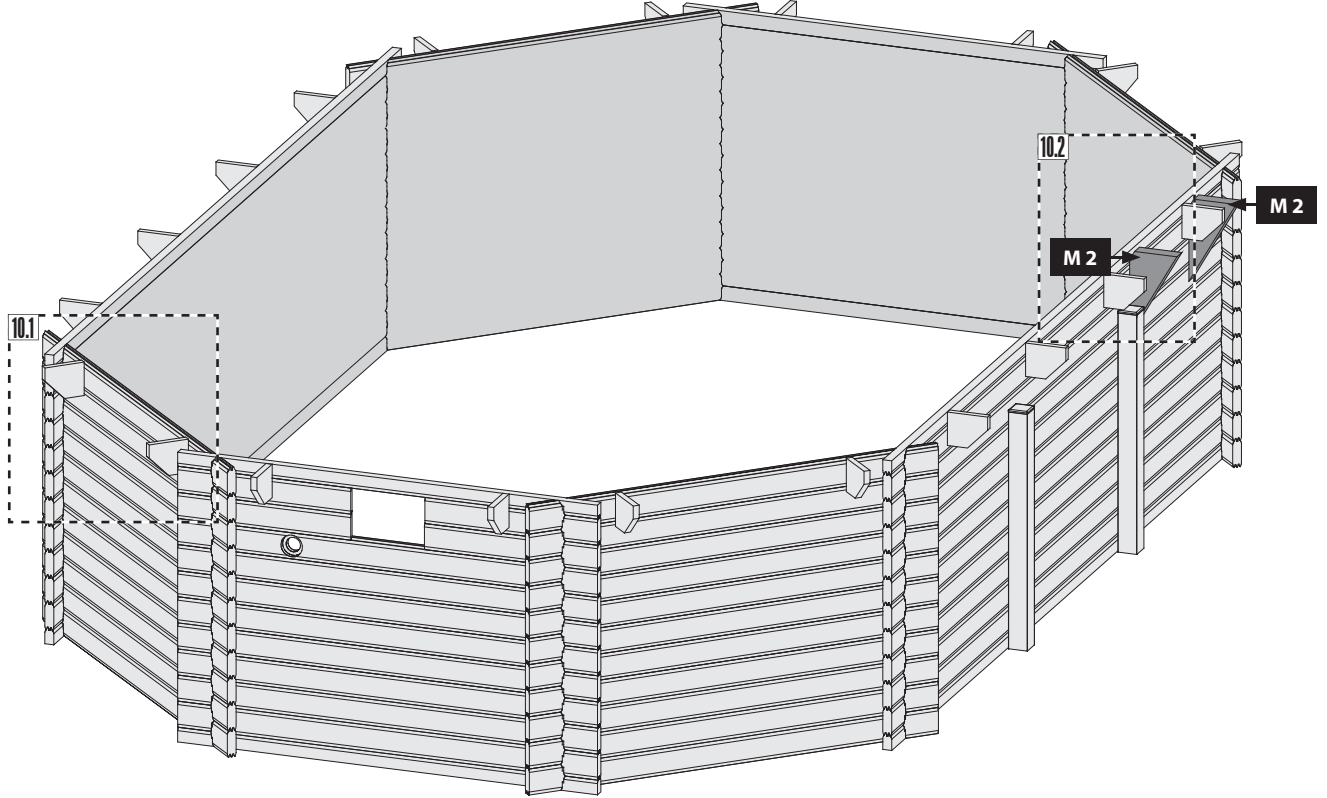

10.1

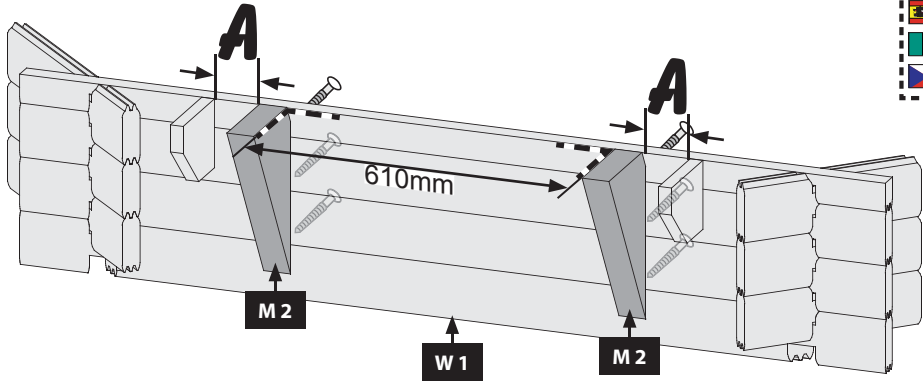

10.2

-  Bündig!
-  Flush!
-  Affleurement!
-  Gelijk!
-  I flugt!
-  Aras!
-  Combacia!
-  Stejný !

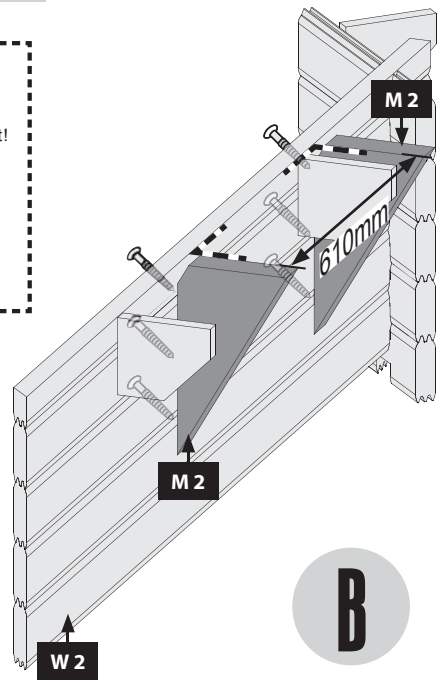

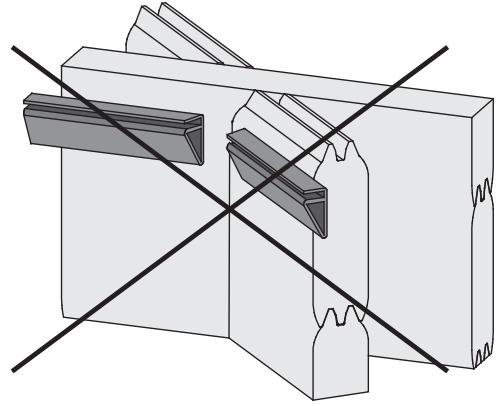
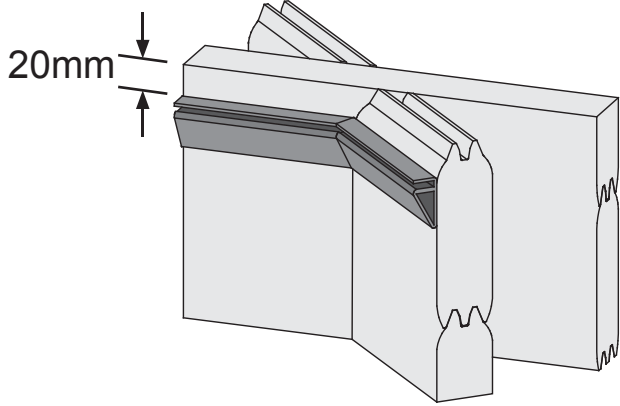
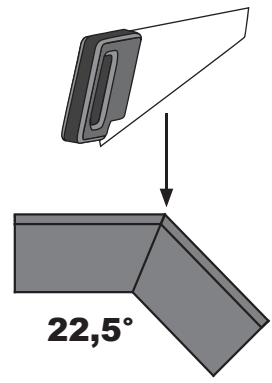
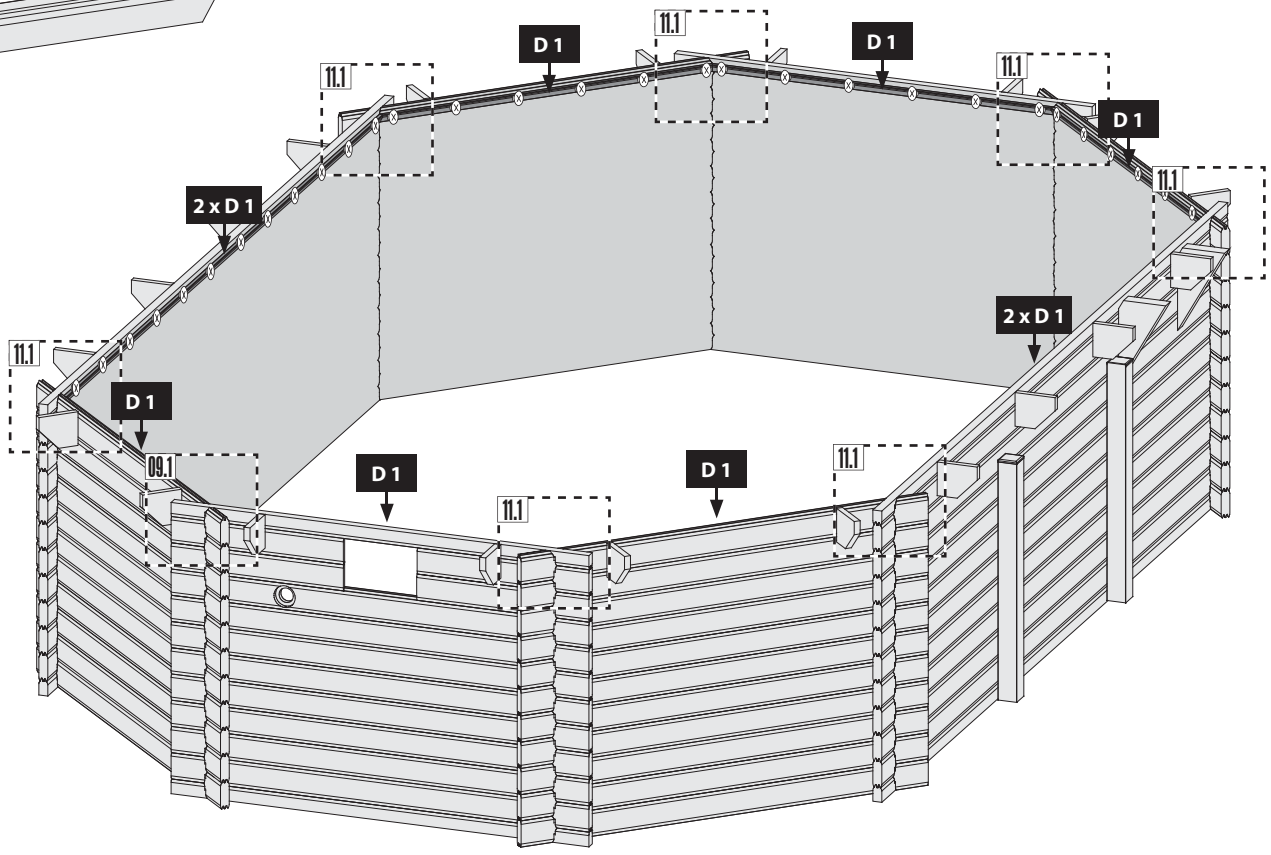
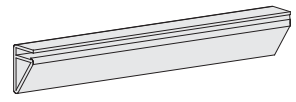
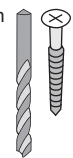

Ø 6mm

Ø 3mm

1.

2.

3.

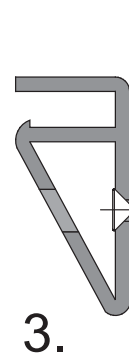
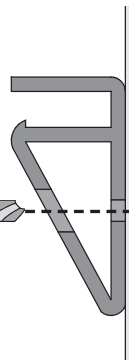
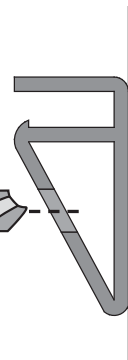

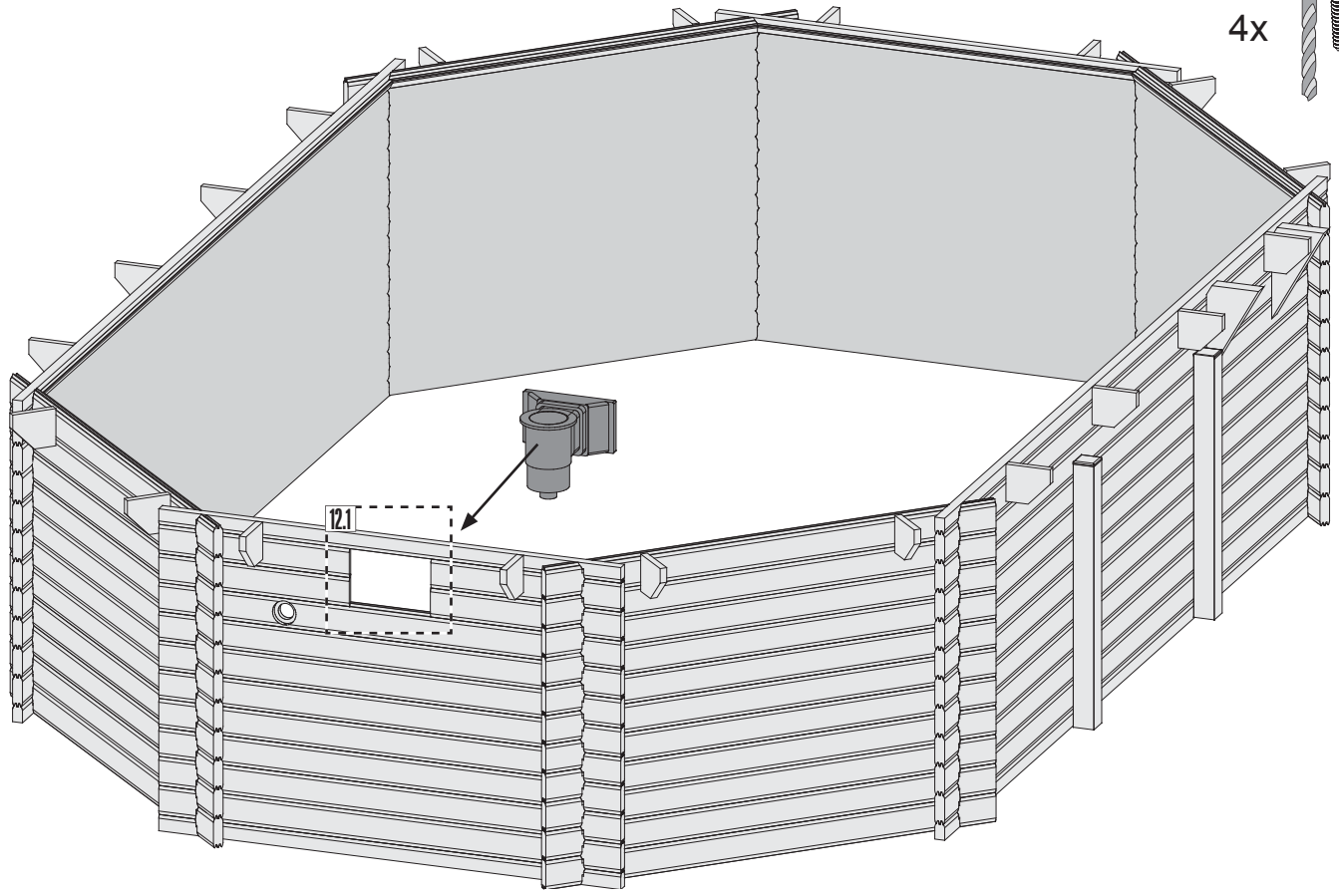

12.1-1

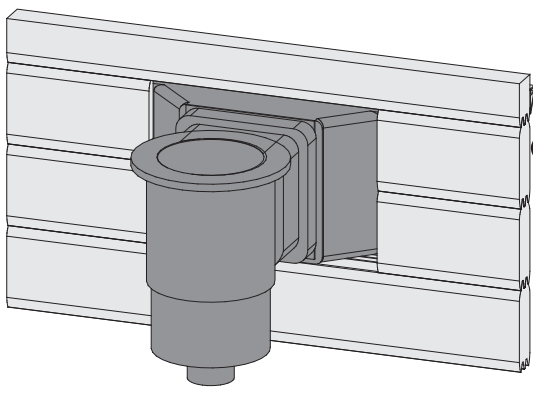

12.1-2

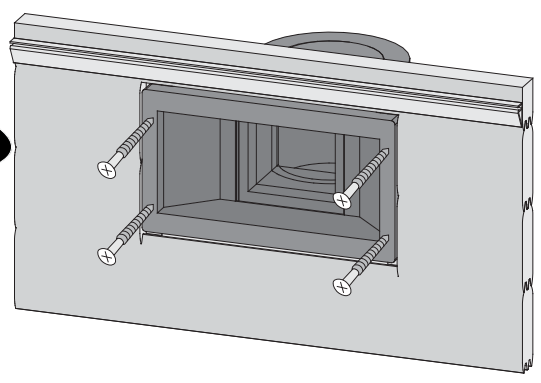
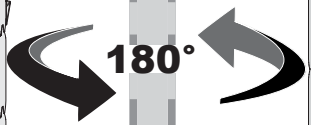

12.1-3

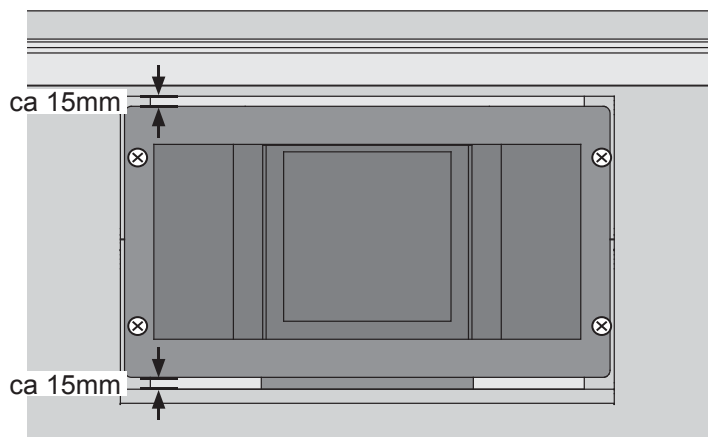

-  innen
-  Inside
-  à l'intérieur
-  binnen
-  inde
-  dentro
-  dentro
-  uvnitř

-  Vlies
-  Fleece
-  Membrane pour piscine
-  Vlies
-  Fleece
-  Vellón
-  Vello
-  Fleece

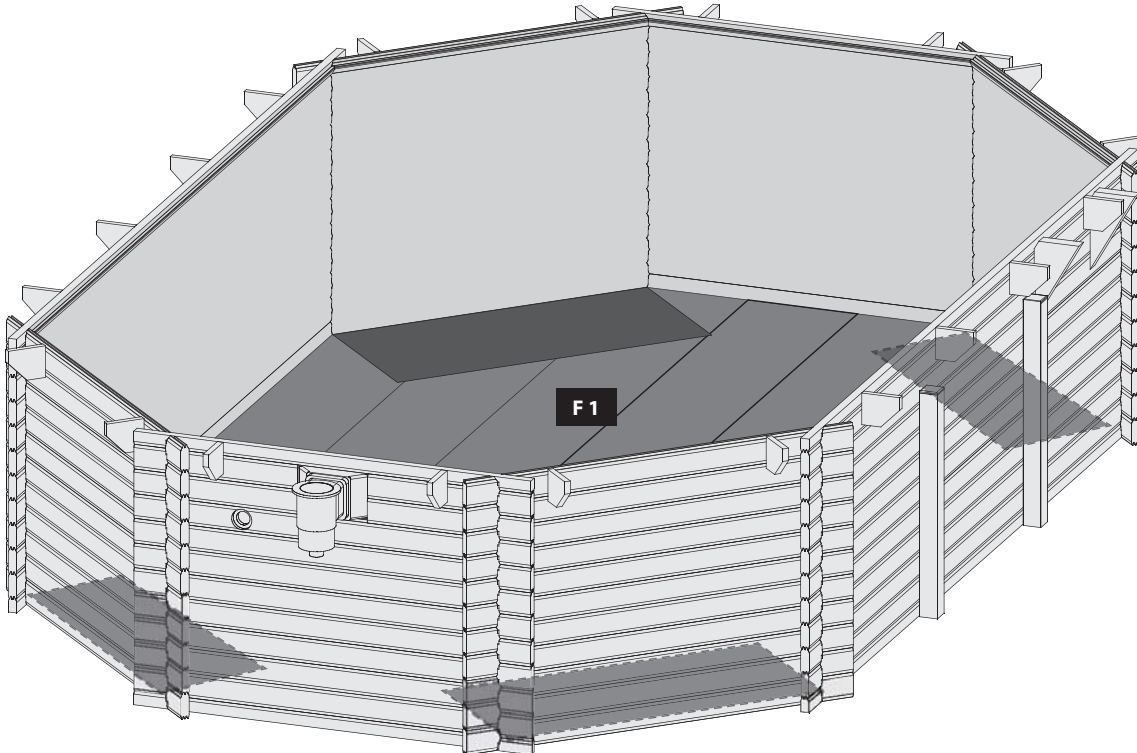
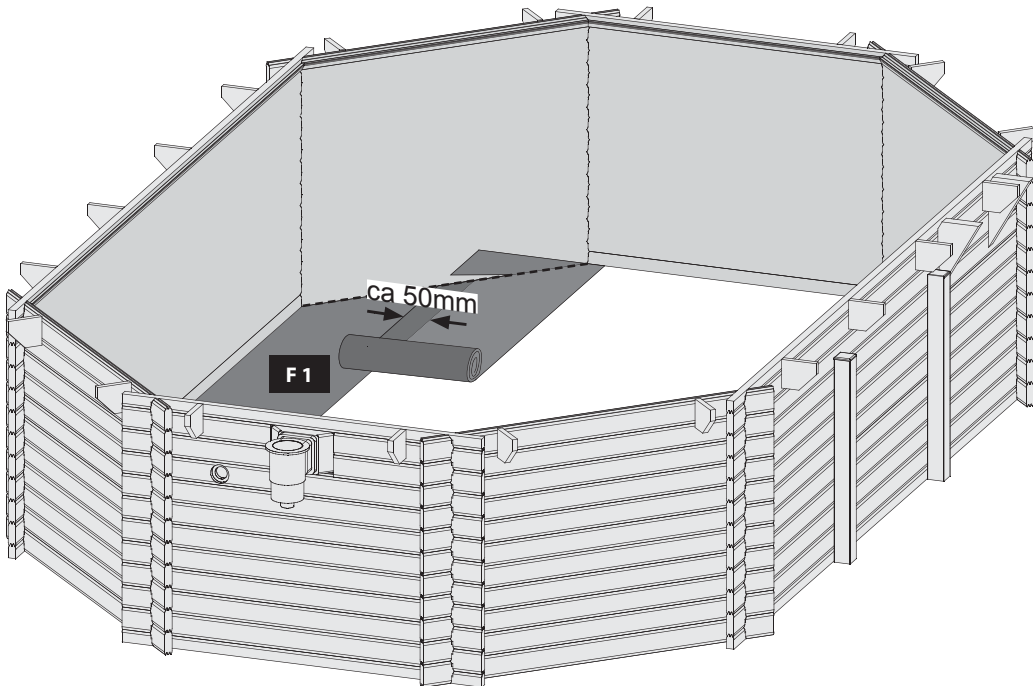
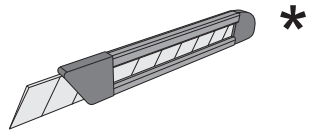
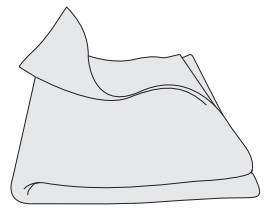

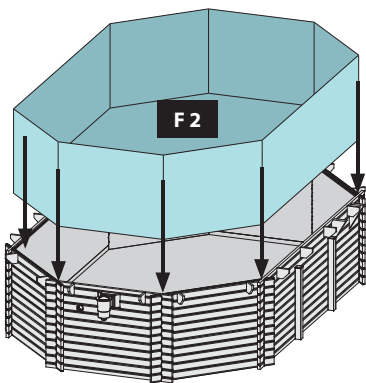
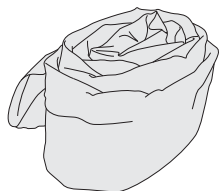



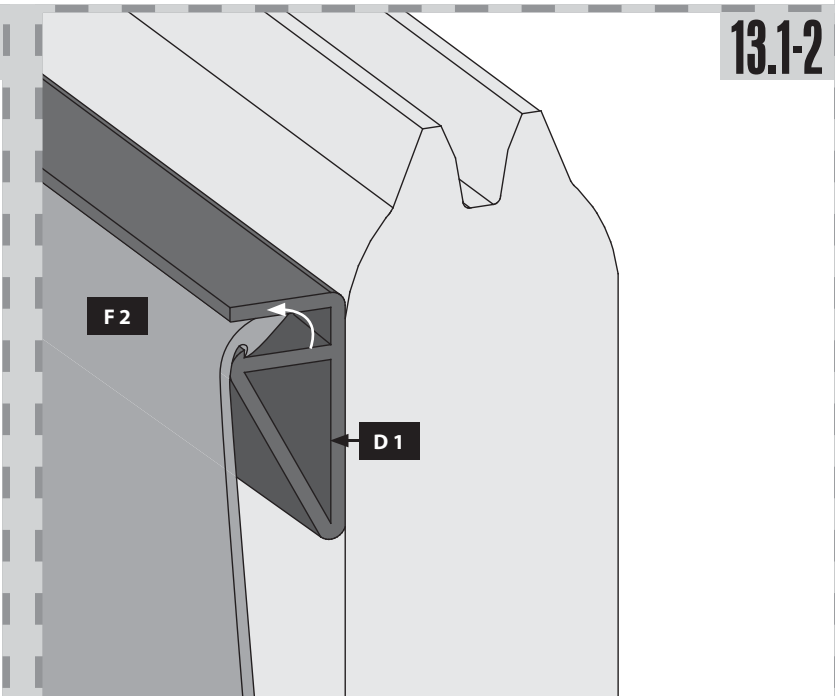
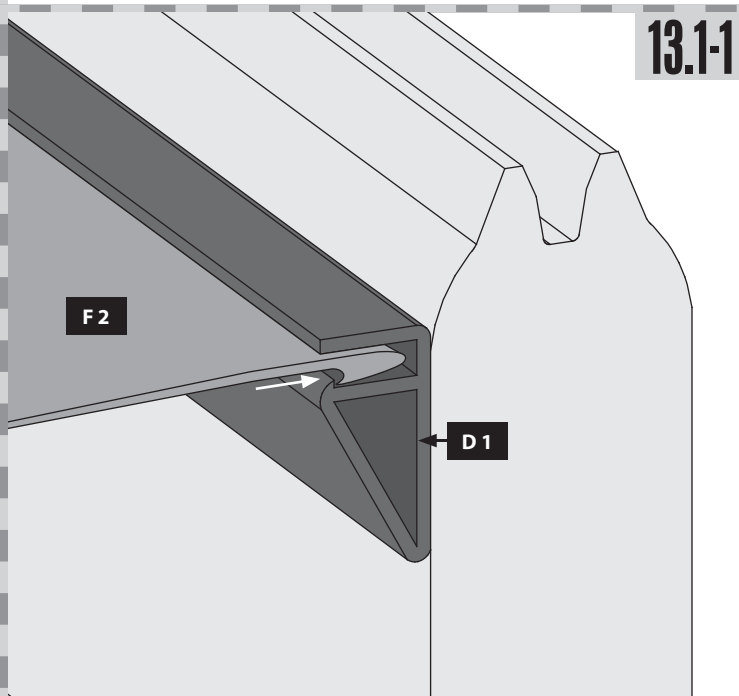
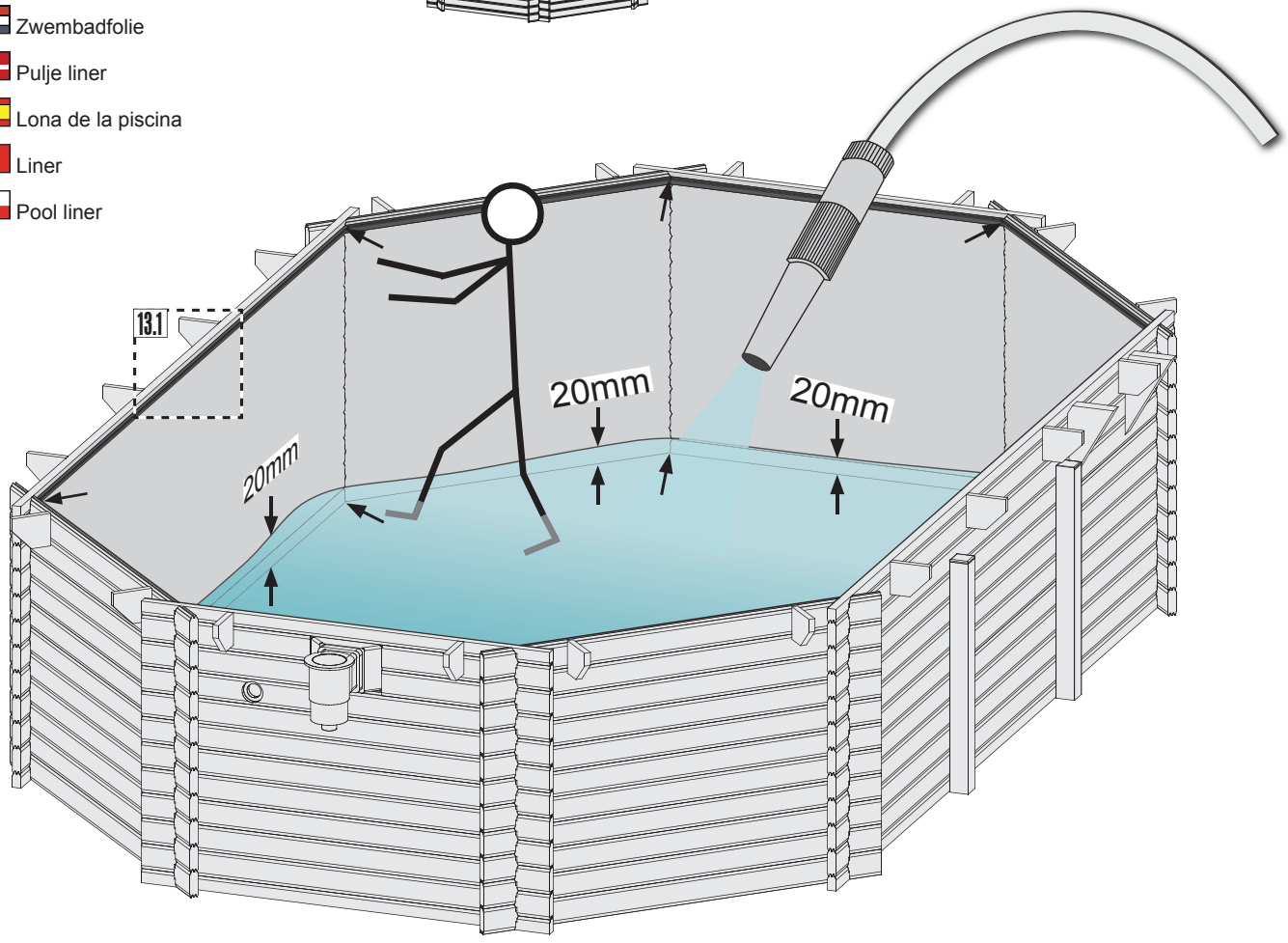

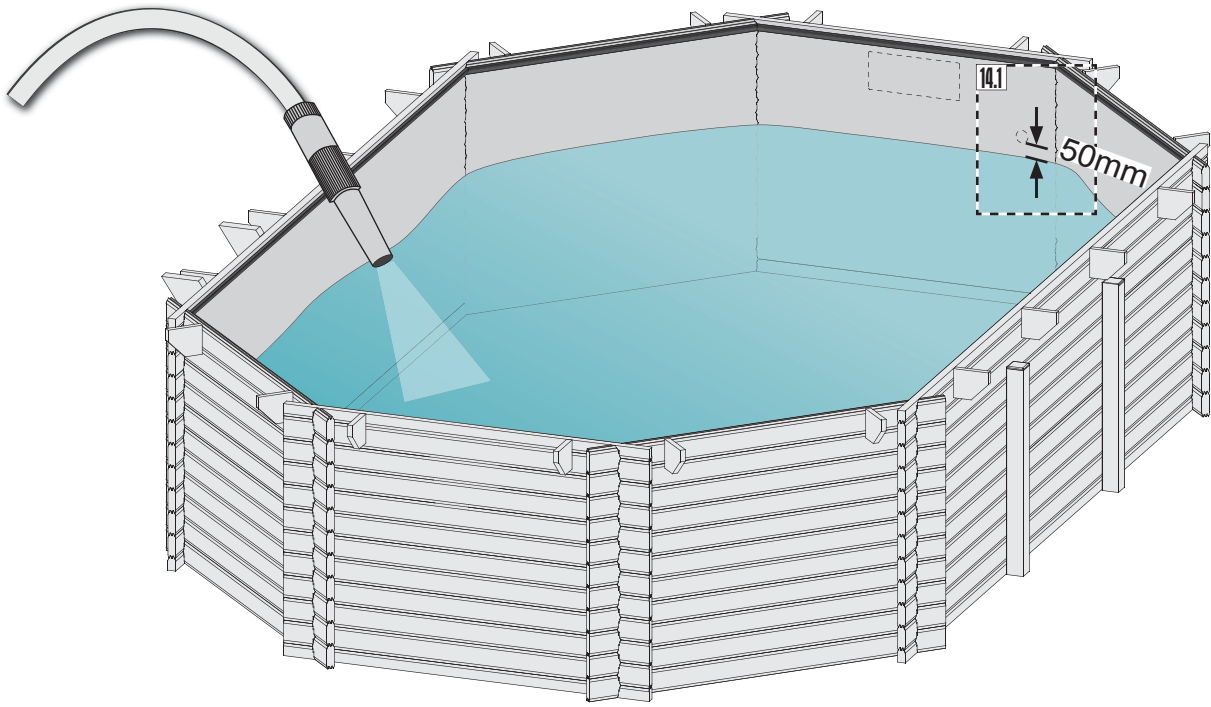



-  Poolfolie
-  Pool liner
-  Feutre de protection du sol
-  Zwembadfolie
-  Pulje liner
-  Lona de la piscina
-  Liner
-  Pool liner





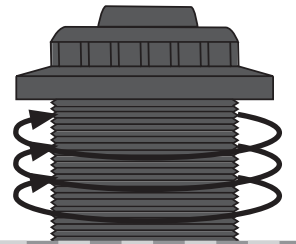

-  Gewindedichtband
-  Schroefdraadafdichtband
-  Thread sealing tape
-  Fil ruban d'étanchéité

-  Cinta de sellado de rosca
-  Nastro sigillante Discussione
-  Závít páska
-  Tråd forseglingsstapen

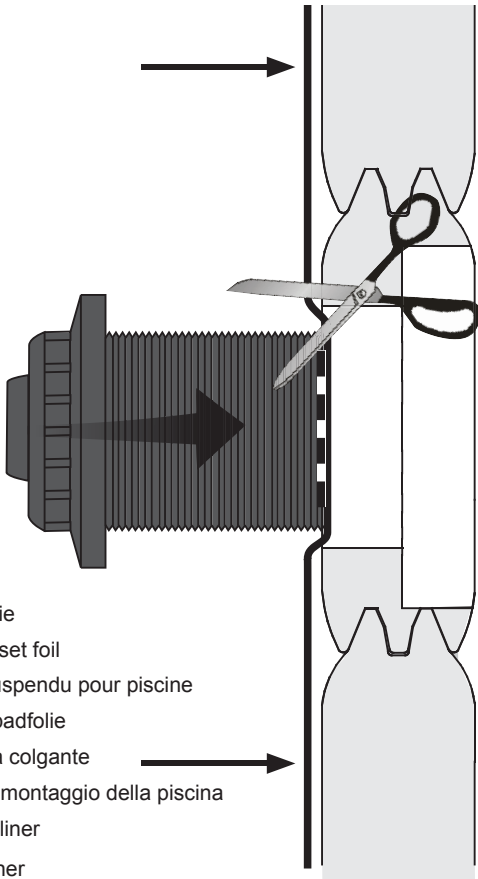

14.1-1



-  Poolfolie
-  Pool inset foil
-  Film suspendu pour piscine
-  Zwembadfolie
-  Lámina colgante
-  Telo di montaggio della piscina
-  Bazén liner
-  pulje liner

14.1-2

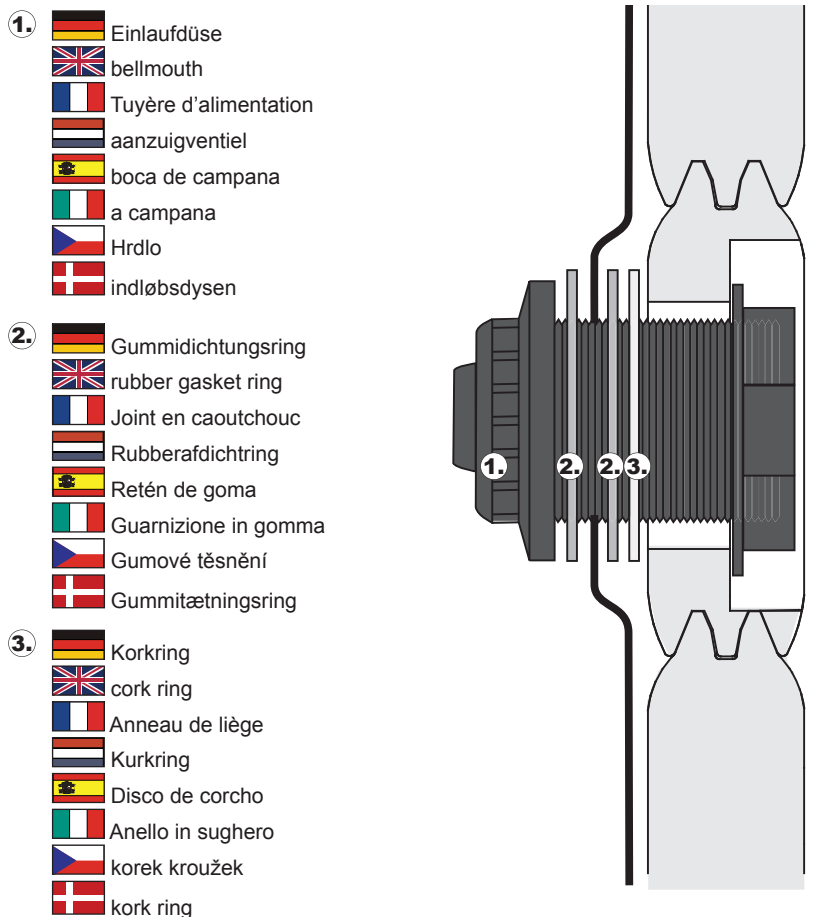

1.  Einlaufdüse
-  bellmouth
-  Tuyère d'alimentation
-  aanzuigventiel
-  boca de campana
-  a campana
-  Hrdlo
-  indløbsdysen

2.  Gummidichtungsring
-  rubber gasket ring
-  Joint en caoutchouc
-  Rubberafdichtring
-  Retén de goma
-  Guarnizione in gomma
-  Gumové těsnění
-  Gummitætningsring

3.  Korkring
-  cork ring
-  Anneau de liège
-  Kurkring
-  Disco de corcho
-  Anello in sughero
-  korek kroužek
-  kork ring

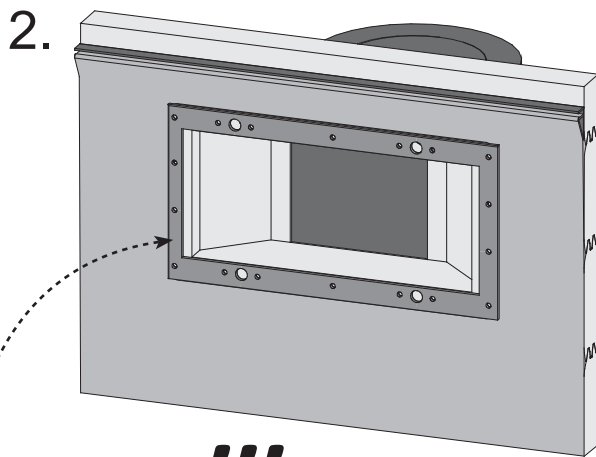
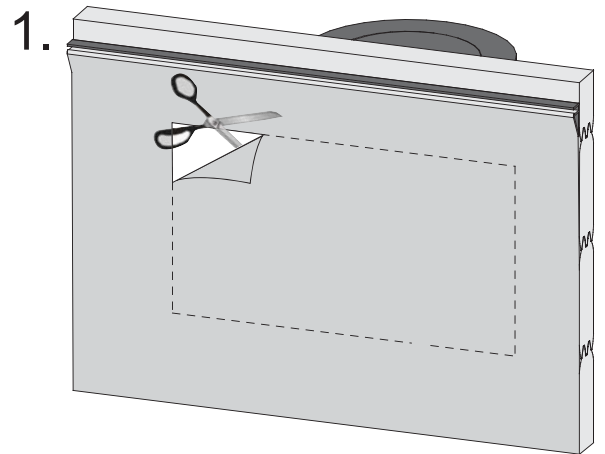
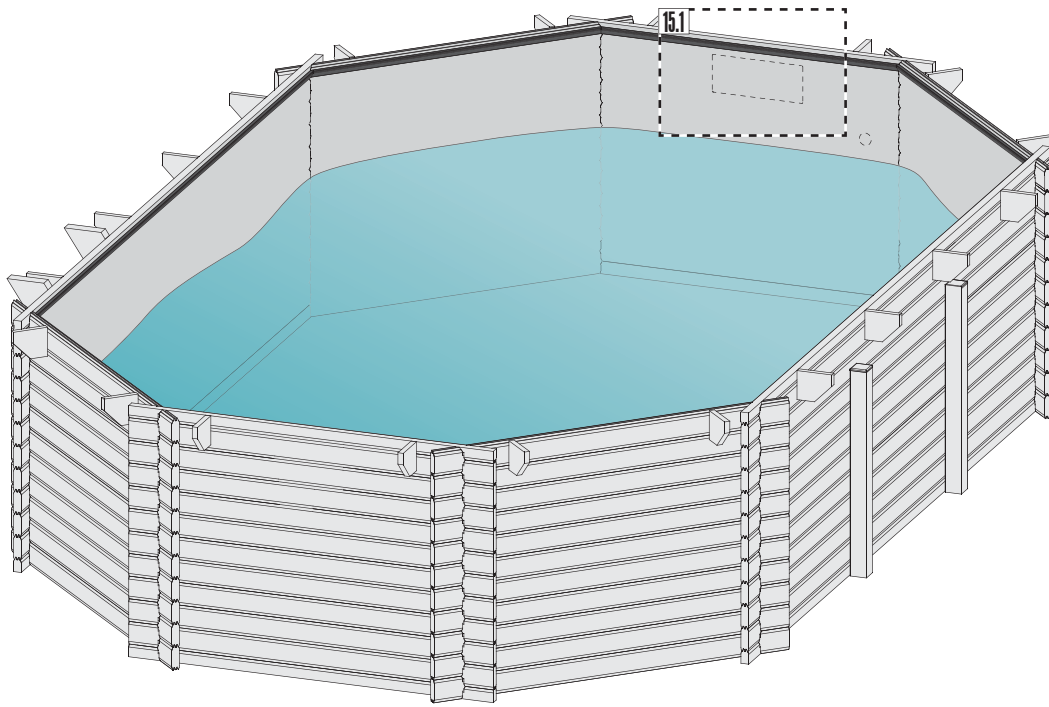



Ø3 mm 4x25

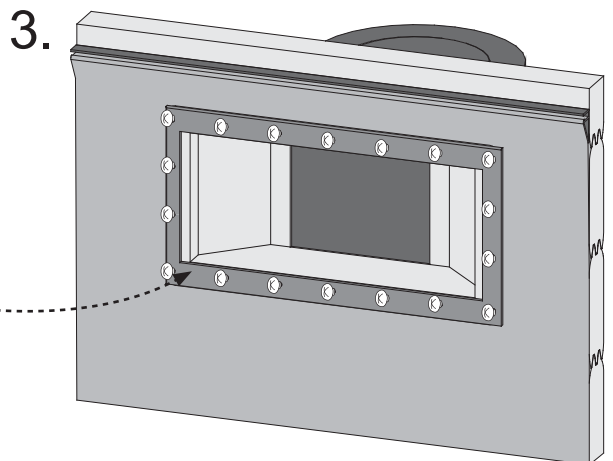
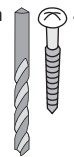

18x





- | | | |
|---|---|--|
|  Gummidichtung |  Poolfolie |  Abdeckung |
|  rubberen afdichting |  liner |  deksel |
|  rubber seal |  pool liner |  cover |
|  joint en caoutchouc |  liner de la piscine |  couverture |
|  sello de goma |  lona de la piscina |  cubierta |
|  guarnizione in gomma |  liner |  copertura |
|  gumové těsnění |  pool liner |  víko |
|  gummitætning |  pulje folie |  dæksel |



 Installation des Pool Filters
 Installation of the pool filter
 Installation du filtre

 Installatie pool filter
 installation af filteret
 Instalación del filtro

 Installazione il filtro
 Instalace filtru

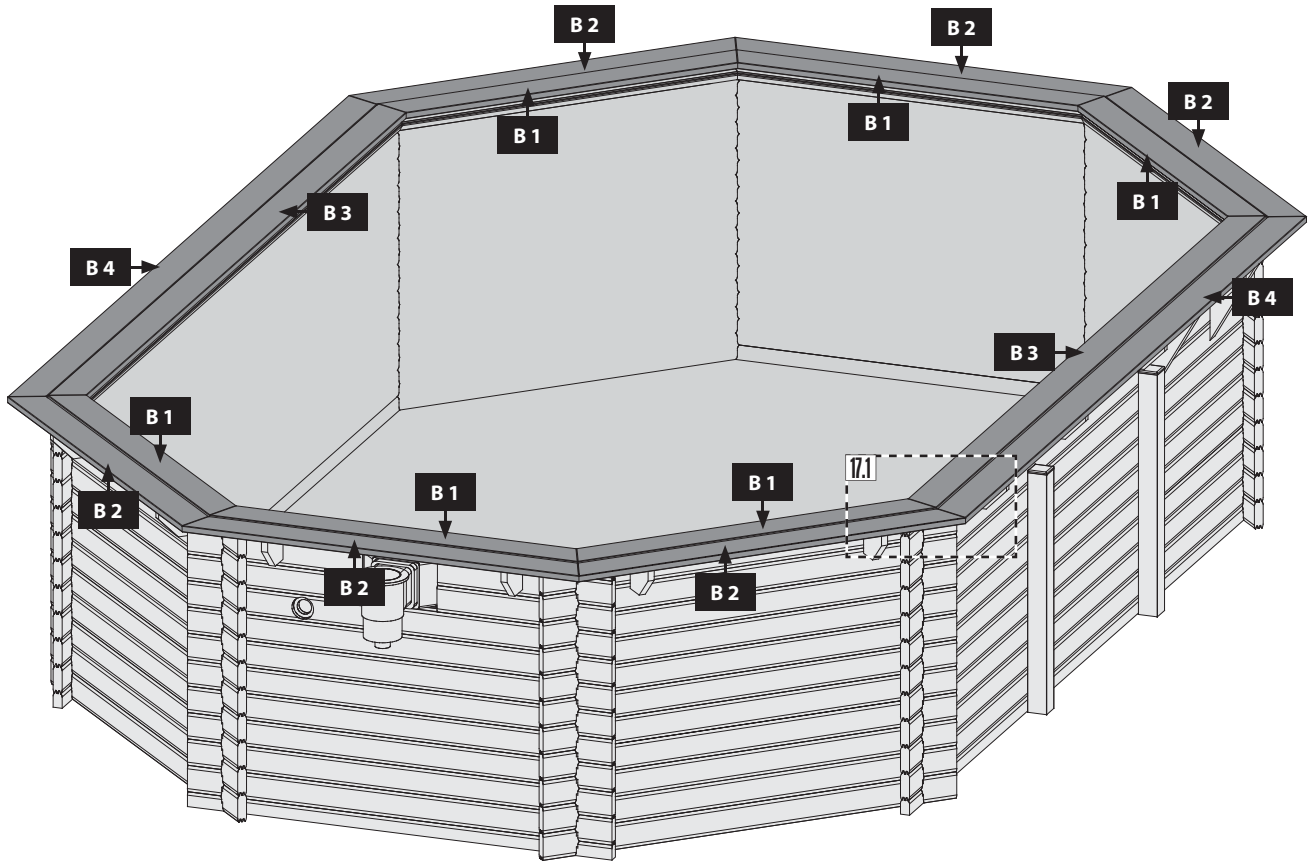

17.1-1

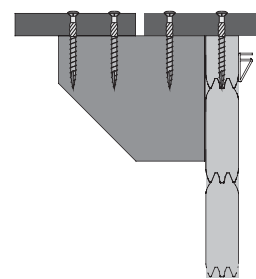
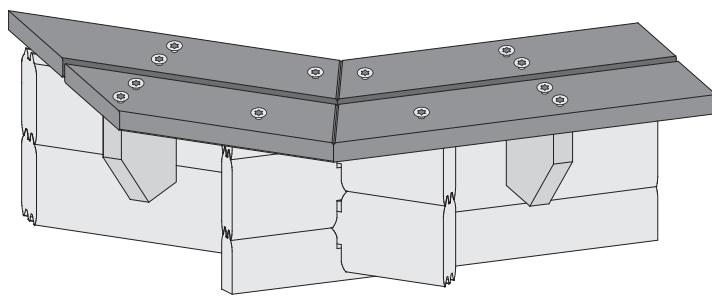

Ø4 mm 5x50

112x

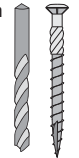

17.1-2

8x

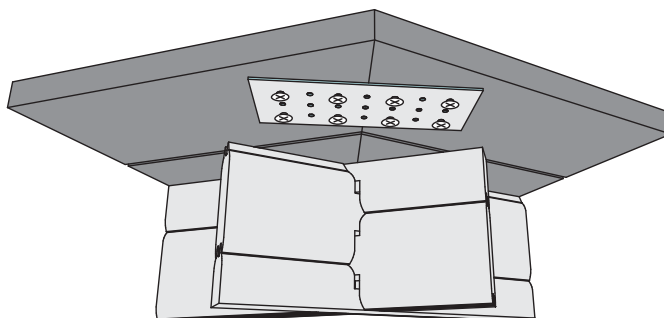

Ø3 mm 4x25

8x

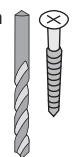

18

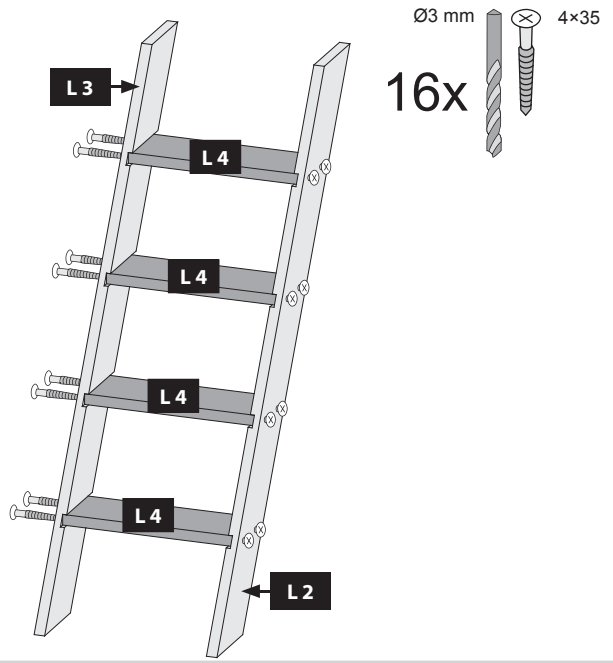

19

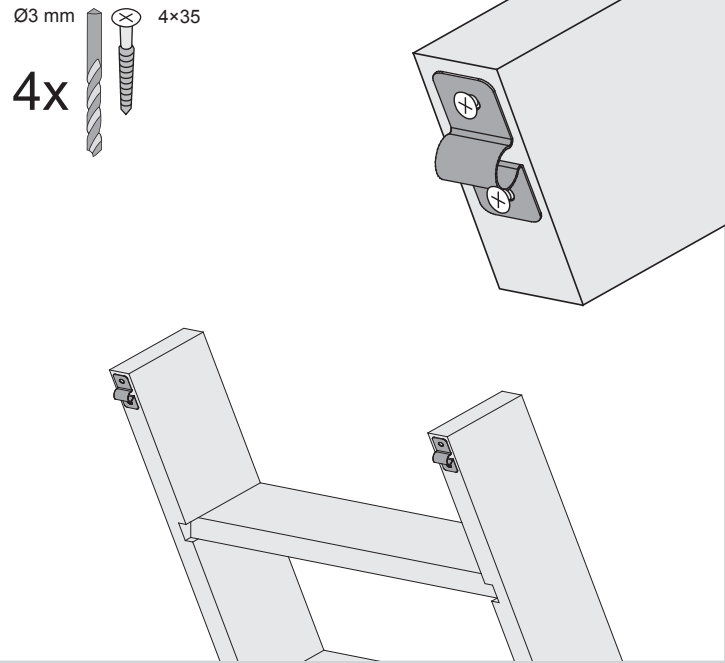

20

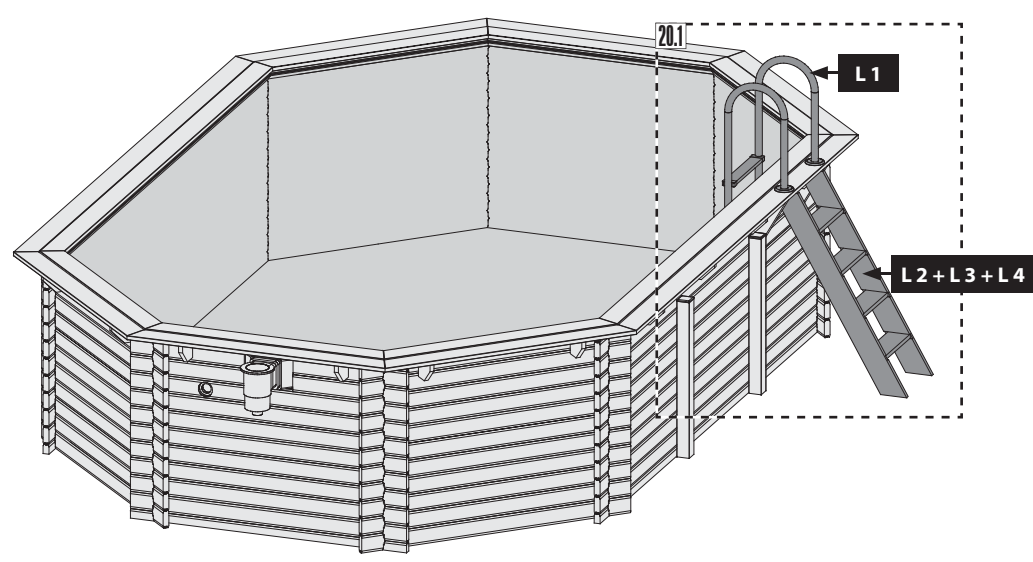

20.1-1

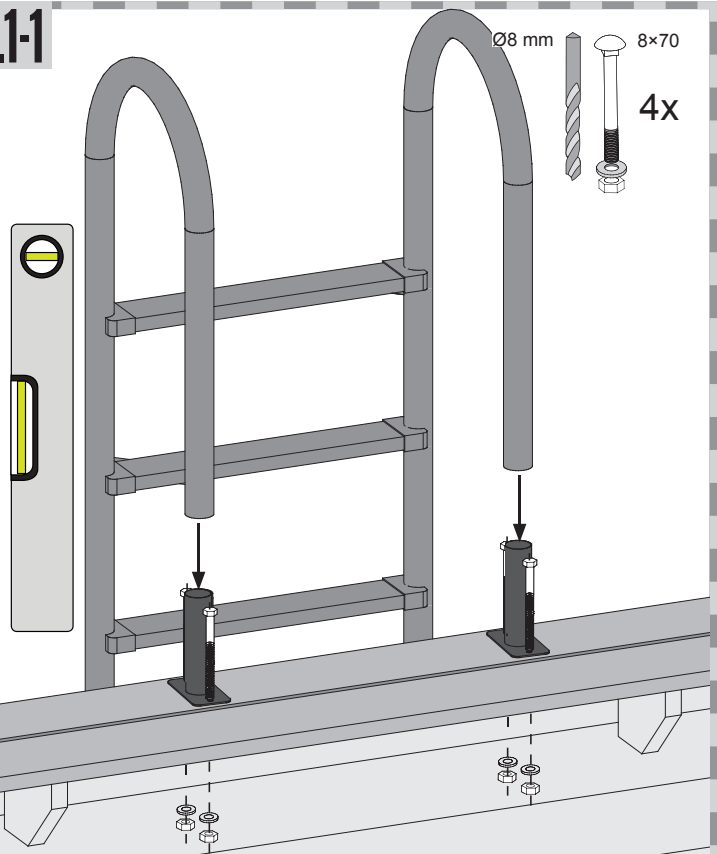

20.1-2

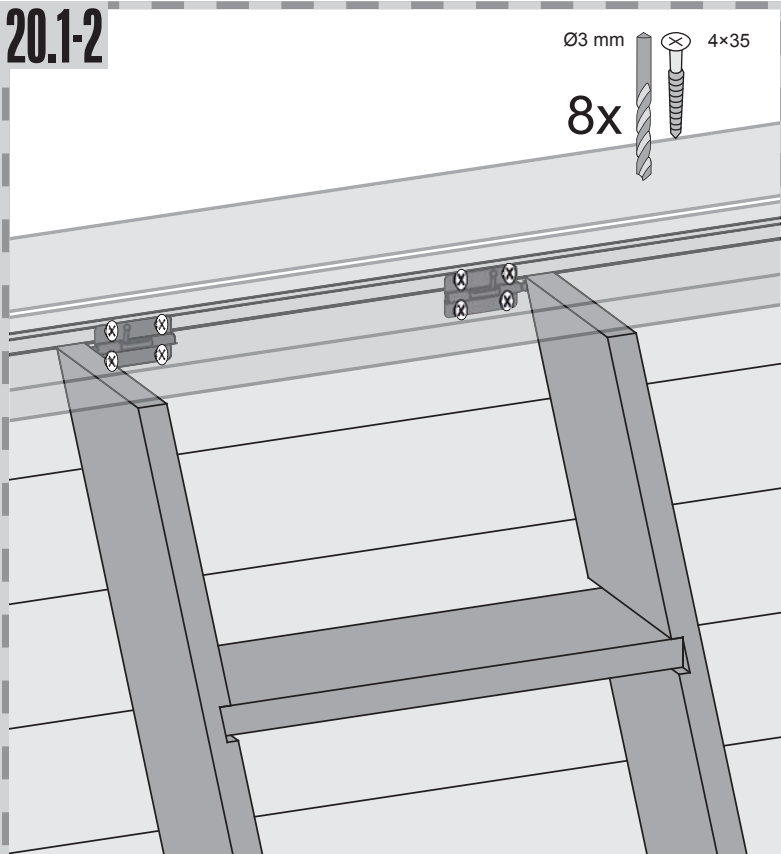

 **Poolpflege im Herbst und Winter**

- Ist der Pool von vielen Pflanzen und Bäumen umgeben, muss dieser regelmäßig vom Laub befreit werden. Sind dennoch Blätter auf den Grund gesunken, müssen diese aufgrund von Schlammabildung zeitnah entfernt werden. Für den entsprechenden Schutz empfehlen wir die Winterabdeckfolie aus unserem Sortiment!
- Im Winter sollte der Pool nicht komplett entleert werden, da seitlicher Eisdruck entstehen kann. Der Wasserstand sollte bis unter die oberen Einläufe abgesenkt werden (ca 10-15 cm unter der Düse) und konstant auf diesem Niveau gehalten werden!
- Alle frostgefährdeten Leitungen und die Filteranlage vollständig entleeren, reinigen und trocken/frostsicher einlagern. Dies gilt für alle Zubehörteile aus Kunststoff und solche, die eingetaucht werden. (Das 6-Wege-Ventil der Filteranlage auf ENTLEREEN stellen. Weiter sollte der Sandfilterdeckel geöffnet werden, damit Luft in das System gelangt. Durch das Öffnen der Entleerungsschraube am Filterkessel und an der Filterpumpe kann das Wasser nun ablaufen.)
- Den Vorfilterdeckel der Filterpumpe abnehmen und Sieb reinigen.
- Alle Betriebschalter auf AUS stellen und den Netzschalter ausschalten. Die Sicherungen entfernen.

 **Pool maintenance in autumn and winter**

- If the pool is surrounded by many plants and trees, it must be regularly removed from the leaves. nevertheless leaves are dropped to the ground, they must be removed promptly due to sludge formation. For the appropriate protection, we recommend the cover from our range!
- In winter, the pool should not be completely drained, because lateral ice pressure may arise. The water level should be lowered to below the upper inlets (About 10-15 cm below the nozzle) and held constant at this level are!
- Empty all frost exposed pipes and the filter system completely, clean and dry / store frost. This applies to all components of plastic and those which are immersed filters (The 6-way valve of the filter system to EMPTY. Next the sand filter cover should be opened to allow air into the system arrives. By opening the drain screw on the filter vessel and the filter pump the water can run now.)
- The preliminary filter, the filter pump and then clean sieve.
- Set all the power switch off and disconnect the mains cable. Remove the fuses.

 **Entretien de la piscine à l'automne et l'hiver**

- Si la piscine est entourée par de nombreuses plantes et des arbres, il doit être régulièrement retiré des feuilles. néanmoins les feuilles sont tombées à terre, ils doivent être rapidement retirés en raison de la formation de boues. Pour la protection appropriée, nous recommandons la couverture de notre gamme!
- En hiver, la piscine ne doit pas être complètement vidé, parce que la pression de la glace latérale peut se poser. Le niveau d'eau devrait être abaissé au-dessous des prises supérieures (environ 10-15 cm en dessous de la buse) être et maintenue constante à ce niveau!
- Videz les tuyaux de gel exposés et complètement le système de filtre, propre et sec / magasin gel. Cela vaut pour tous les éléments de plastique et ceux qui sont immergés. (Placez la vanne 6 voies du système de filtre à VIDER. Ensuite, le couvercle du filtre à sable doit être ouvert pour permettre à l'air dans le système. En ouvrant la vis de vidange sur la cuve de filtre et la pompe de filtration, l'eau peut maintenant procéder.)
- Le filtre préliminaire, la pompe à filtre et tamis puis nettoyer.
- Réglez tout l'appareil hors tension et débranchez le câble d'alimentation. Retirer les fusibles.

 **Zwembad onderhoud in de herfst en winter**

- Als het zwembad is omgeven door veel planten en bomen, het moet regelmatig worden verwijderd uit de bladeren. Toch bladeren viel op de grond, moeten zij onmiddellijk worden verwijderd als gevolg van slibvorming. Voor de juiste bescherming, raden we het deksel van ons assortiment!
- In de winter is het zwembad mag niet worden helemaal leeg, omdat zijdelingse ijs druk kunnen ontstaan. Het waterniveau worden verlaagd tot onder de bovenste inname (ongeveer 10-15 cm onder het mondstuk) en constant gehouden op dit niveau!
- Leeg alle vorst blootgesteld leidingen en het filter systeem volledig, schoon en droog / store vorst. Dit geldt voor alle onderdelen van kunststof en die zijn ondergedompeld. (Plaats de 6-weg klep van het filtersysteem te legen. Vervolgens wordt de zandfilter kap moet worden geopend om lucht in het systeem. Door het openen van de afvoer schroef op de filter vat en de filter pomp, het water kan nu verder gaan.)
- Het voorfilter, het filter pomp en vervolgens schoon zeef.
- Zet de stroom uit te schakelen en de stekker uit het netsnoer. Verwijder de zekeringen.

 **Mantenimiento de la piscina en otoño e invierno**

- Si la piscina está rodeada de muchas plantas y árboles, se debe retirarse periódicamente las hojas. sin embargo, las hojas se dejan caer al suelo, deben ser eliminado rápidamente debido a la formación de lodos. Para la protección adecuada, se recomienda la tapa de nuestra gama!
- En invierno, la piscina no debe ser completamente agotada, porque puede surgir la presión del hielo lateral. El nivel del agua debe ser bajado por debajo de las ingestas superiores (unos 10-15 cm por debajo de la boquilla) y se mantuvo constante a este nivel!
- Vaciar todas las tuberías heladas expuesta y el sistema de filtro por completo, limpio y seco / tienda de heladas. Esto se aplica a todos los componentes de plástico y los que están inmersos. (Coloque la válvula de 6 vías del sistema de filtro en VACÍO. A continuación, la tapa del filtro de arena debe ser abierta para permitir que el aire en el sistema. Con la apertura de la válvula de drenaje en el recipiente del filtro y la bomba del filtro, el agua puede ahora proceder.)
- El filtro previo, la bomba de filtro y tamiz luego limpia.
- fijado todo el interruptor de encendido y desconecte el cable de red. Retire los fusibles.

Manutenzione della piscina in autunno e inverno

- Se la piscina è circondata da molte piante e alberi, deve essere rimosso regolarmente dalle foglie. tuttavia le foglie sono caduti a terra, essi devono essere rimosso prontamente a causa della formazione di fanghi. Per la protezione del caso, si consiglia la copertura della nostra gamma!
- In inverno, la piscina non dovrebbe essere completamente scarica, perché la pressione del ghiaccio laterale può sorgere. Il livello dell'acqua dovrebbe essere abbassato al di sotto le prese superiori (circa 10-15 cm sotto l'ugello) essere e mantenuta costante a questo livello!
- Svuotare tutti i tubi di gelo a vista e il sistema di filtraggio completamente, pulito ed asciutto / store gelo. Questo vale per tutti i componenti in plastica e quelli che sono immersi. (Posizionare la valvola 6 vie del sistema di filtrazione a vuoto. Successivamente il coperchio del filtro sabbia deve essere aperto per consentire aria nel sistema. Aprendo la vite di scarico sulla nave filtro e la pompa del filtro, l'acqua può ora procedere.)
- Il filtro preliminare, la pompa filtro e vaglio quindi pulita.
- Impostare tutto il potere spegnere e scollegare il cavo di alimentazione. Rimuovere i fusibili.

Údržba na podzim av zimě bazén

- Pokud je bazén obklopen mnoha rostlin a stromů, musí být pravidelně odstraňovány z listů. Nicméně listy jsou spadl na zem, musí být neprodleně odstranit v důsledku tvorby kalu. Za vhodnou ochranou, doporučujeme kryt z naší nabídky!
- V zimě, bazén by neměly být zcela vypuštěny, protože mohou vzniknout boční tlak ledu. Hladina vody by měla být snížena pod horními vstupy (cca 10 až 15 cm pod tryskou), se udržuje konstantní, a na této úrovni!
- Prázdná všechny mráz vystavení potrubí a filtrační systém zcela čistý a suchý / sklad mrazu. To platí pro všechny součásti z plastů a ty, které jsou ponořeny. (Umístěte 6-cestný ventil filtračního systému na prázdný. Dále je kryt pískový filtr by měl být otevřený, aby vzduchu do systému. Otevřením vypouštěcího šroubu na filtrační nádoby a filtrační čerpadla, voda může nyní pokračovat.)
- Předběžný filtr, filtr čerpadla a pak čisté síto.
- Nastavte všechny hlavní vypínač a odpojte napájecí kabel. Vyjměte pojistky.

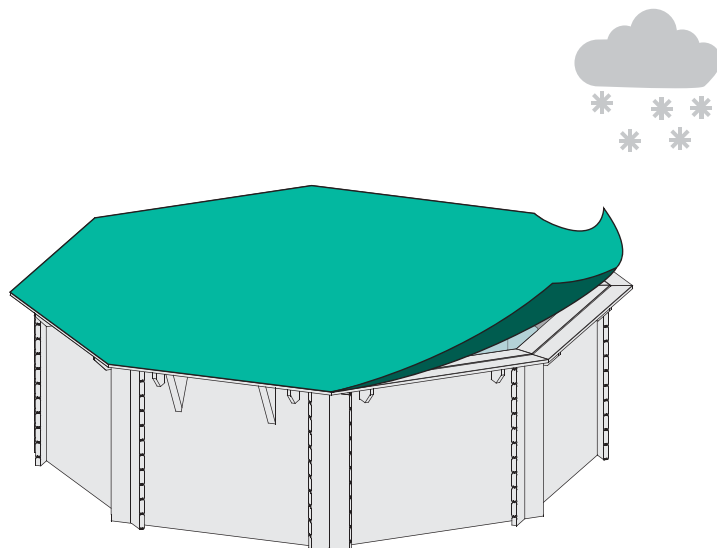
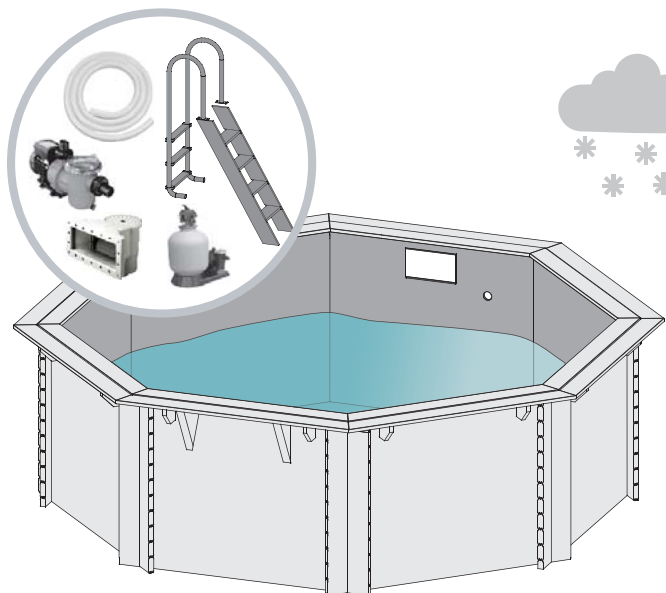
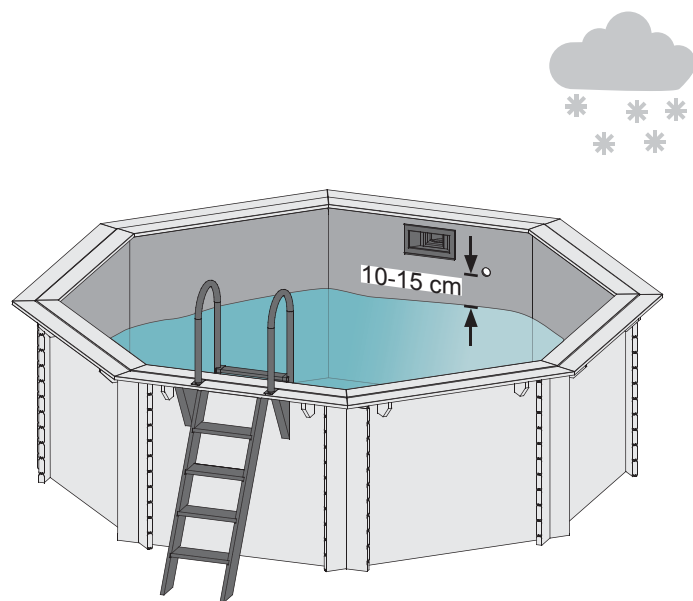
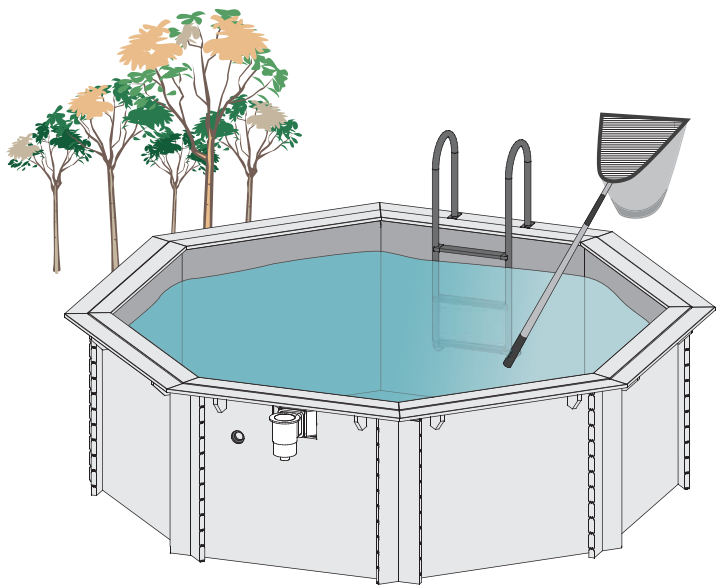

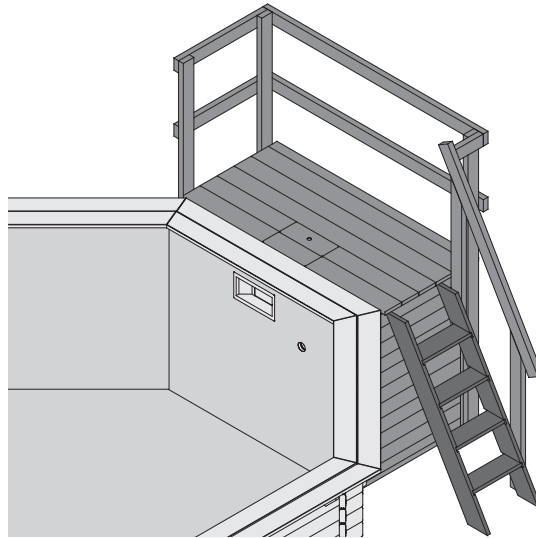

49535



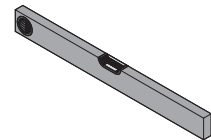
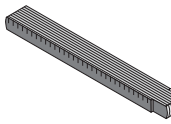
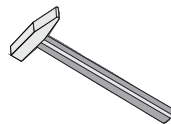
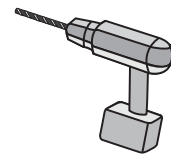
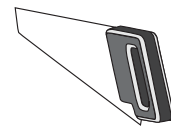

-  **Aufbauanleitung**
-  **Building Instructions**
-  **notice de montage**
-  **montagehandleiding**
-  **Montagevejledning**
-  **Instrucciones de construcción**
-  **Istruzioni per il montaggio**
-  **Montážní návod**





 Vergleichen Sie zuerst die Material-liste mit Ihrem Paketinhalt! Bitte haben Sie Verständnis, dass Beanstandungen nur im nicht aufgebauten Zustand bearbeitet werden können!

 Vergelijk eerst de lijst van materialen met de inhoud van uw pakket! Reclamaties kunnen alleen in behandeling worden genomen zolang de onderdelen nog niet zijn gemonteerd!

 Confrontate questa distinta materiali prima con il contenuto del pacchetto! Vi preghiamo di comprendere che eventuali reclami possono essere accolti solo prima del montaggio!

 First compare the list of materials with your package contents! Please understand that complaints can be processed in the non-built status only!

 Start med at kontrollere materialelisten med indholdet af den leverede pakke! Vi gør venligst opmærksom på at reklamationer kun kan behandles for materialer som ikke er blevet bearbejdet!

 Nejprve překontrolujte obsah balení podle materiálového listu! Mějte pochopení pro to, že případnou reklamaci se můžeme zabývat pouze tehdy, když díly nebudou smontované! Za pomoci tohoto seznamu můžete jednotlivé díly přiřadit k montážnímu návodu.

 Commencez par comparer la liste du matériel avec le contenu de votre paquet! Sachez que nous traitons uniquement les réclamations concernant le matériel à l'état non monté!

 En primer lugar, compare la lista de material con el contenido del paquete. Rogamos entienda que las reclamaciones sólo pueden ser tramitadas antes de montar el objeto!

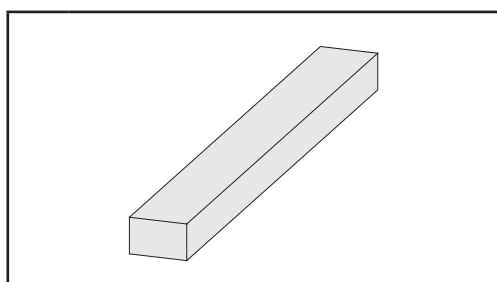
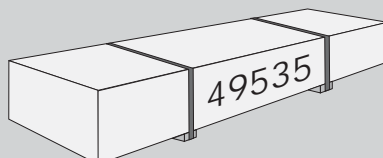

2 x B1	285 x 45 x 18 mm	ID 44871
2 x B2	355 x 140 x 26 mm	ID 49534
4 x B3	420 x 140 x 26 mm	ID 39882
4 x B4	676 x 140 x 26 mm	ID 49500
4 x B5	1717 x 140 x 26 mm	ID 49499
2 x B6	80 x 58 x 28 mm	ID 7205
2 x B7	1040 x 58 x 28 mm	ID 39736
4 x B8	1170 x 58 x 28 mm	ID 39735
2 x B9	943 x 60 x 40 mm	ID 39733
1 x B10	1535 x 60 x 40 mm	ID 39734
1 x B11	235 x 90 x 40 mm	ID 37463
2 x B12	290 x 90 x 40 mm	ID 39915
2 x B13	757 x 90 x 40 mm	ID 49498
4 x B14	878 x 90 x 40 mm	ID 39913
2 x B15	1155 x 90 x 40 mm	ID 39906
2 x B16	1606 x 90 x 40 mm	ID 39910
1 x B17	1537 x 90 x 40 mm	ID 39908
2 x B18	1878 x 90 x 40 mm	ID 43669
3 x B19	2170 x 90 x 40 mm	ID 39909

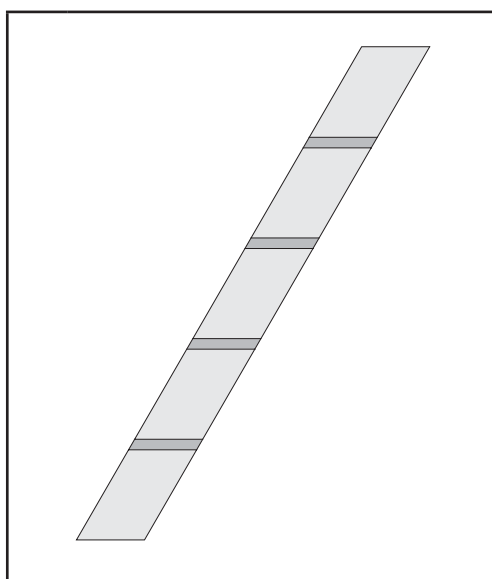

1 x L1 | ID 39880

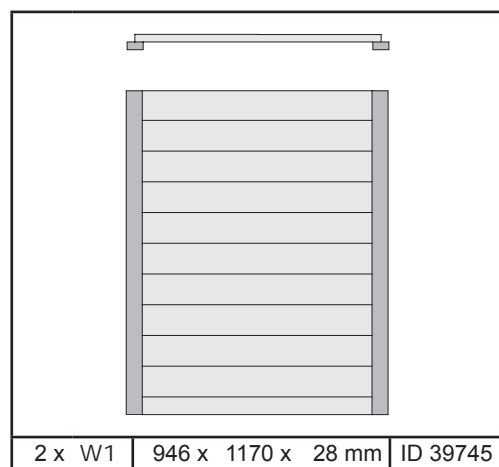

2 x W1 | 946 x 1170 x 28 mm | ID 39745

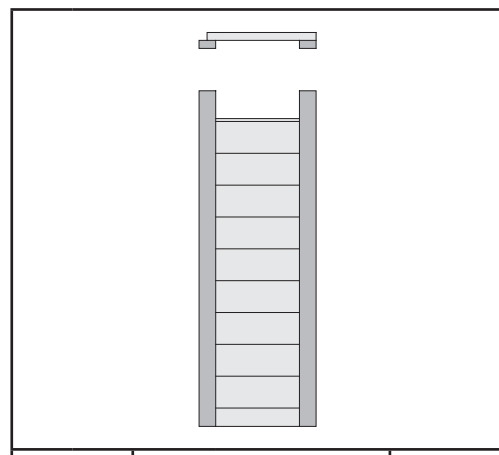

1 x W2 | 408 x 1170 x 28 mm | ID 39746

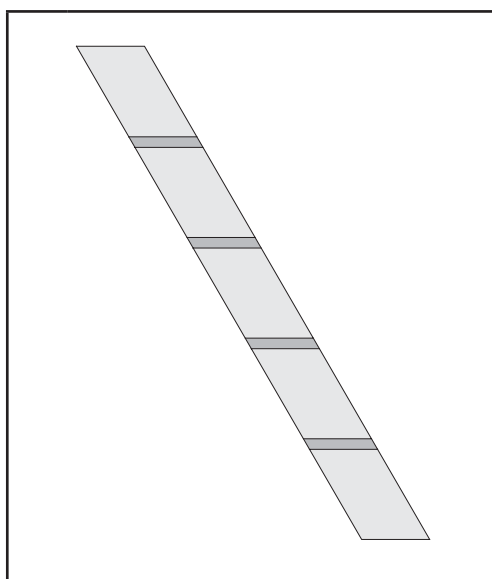

1 x L2 | ID 39881

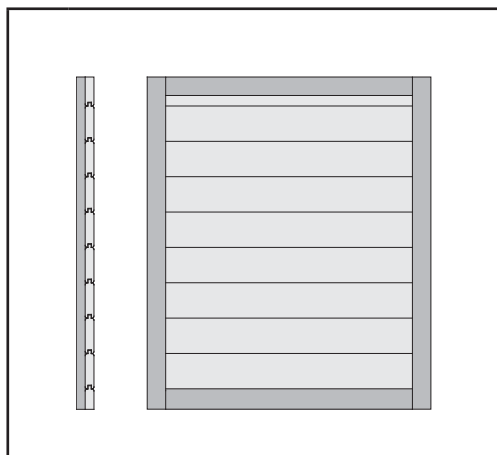

1 x D1 | 1043 x 890 x 28 mm | ID 39766

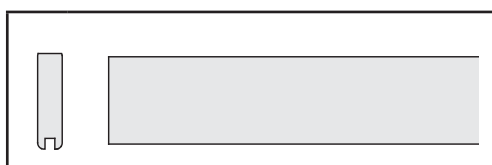

1 x G1 | 1661 x 105 x 28 mm | ID 39748

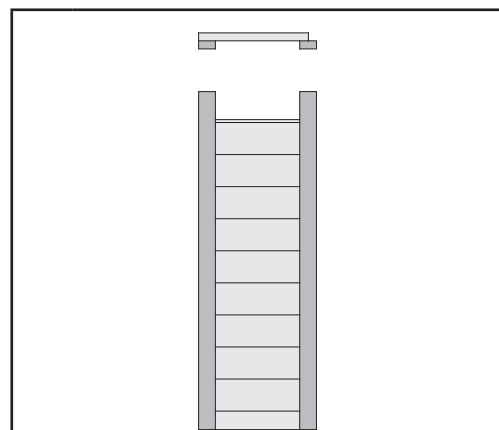

1 x W3 | 408 x 1170 x 28 mm | ID 39901

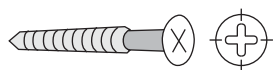
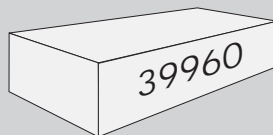

40 x	4 x 35 mm	ID 3687
75 x	4 x 50 mm	ID 3688
60 x	4 x 70 mm	ID 3689

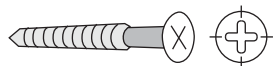

-  Edelstahl
-  stainless steel
-  acier inoxydable
-  roestvrij staal
-  rustfrit stål
-  acero inoxidable
-  acciaio inossidabile
-  nerez

20 x	4 x 35 mm	ID 39398
85 x	4 x 50 mm	ID 39399

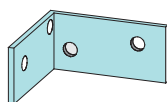

4 x ID 21208

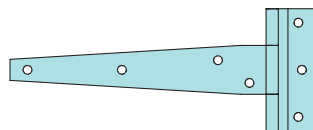

2 x ID 3716

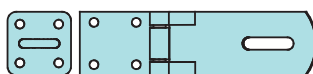

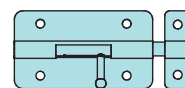

1 x ID 3724





2 x ID 3709

 Um das Ertrinken von Kindern zu verhindern, wird empfohlen, den Zugang zum Schwimmbecken mit einer Schutzeinrichtung zu sichern!

 To prevent the drowning of children, it is recommended to secure access to the swimming pool with a protective device!

 Pour éviter la noyade des enfants, il est recommandé de sécuriser l'accès à la piscine avec un dispositif de protection!

 Om verdrinking van kinderen te voorkomen, is het aan te raden om de toegang tot het zwembad te beveiligen met een beschermend apparaat!

 For at forhindre drukning af børn anbefales det at sikre adgang til swimmingpoolen med en beskyttelsesanordning!

 Para evitar que los niños se ahoguen, se recomienda asegurar el acceso a la piscina con un dispositivo de protección.

 Per prevenire l'annegamento dei bambini, si consiglia di proteggere l'accesso alla piscina con un dispositivo di protezione!

 Aby se zabránilo utopení dětí, doporučuje se zajistit přístup k bazénu s ochranným zařízením!



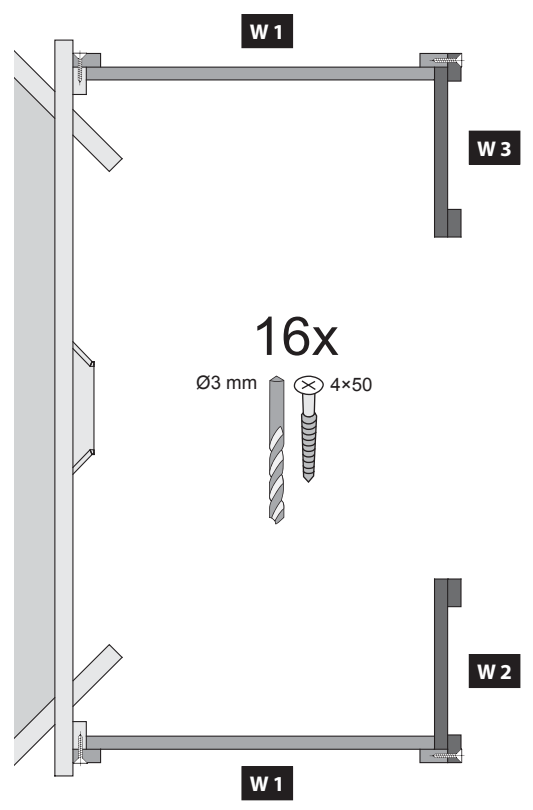
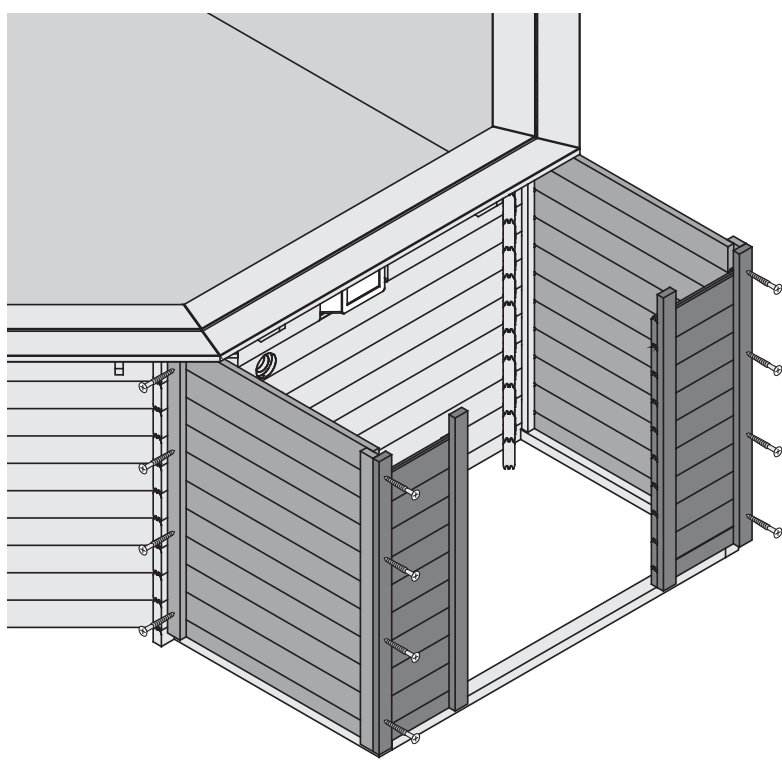
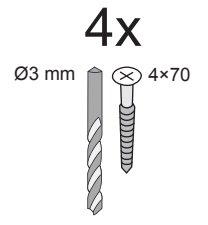
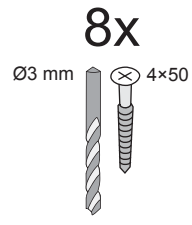
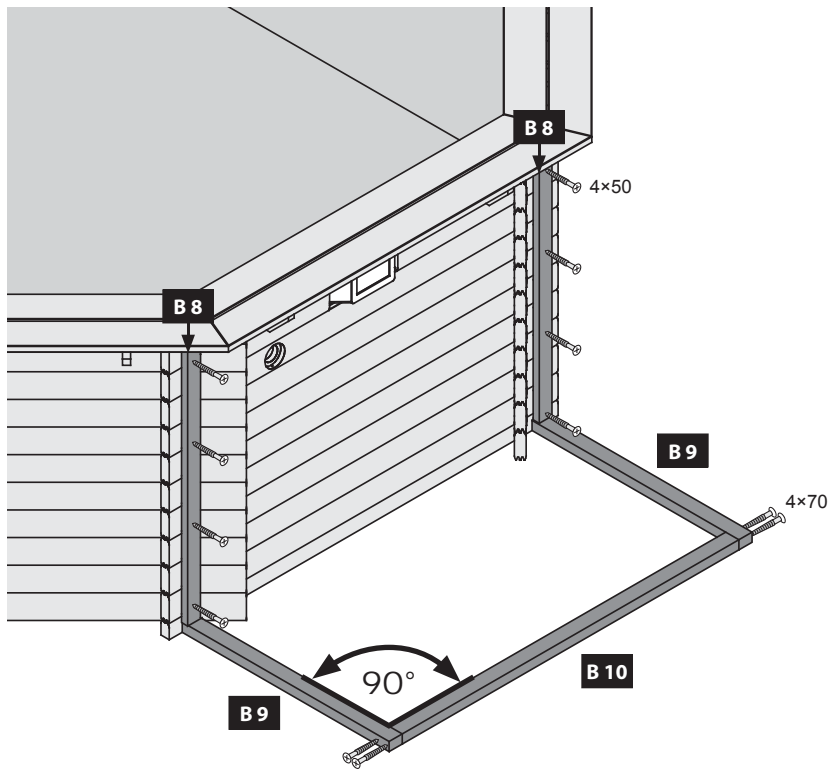

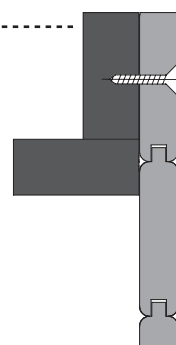
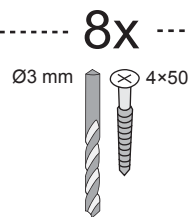
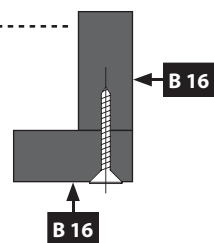
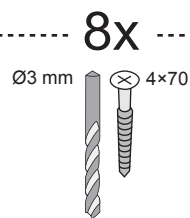
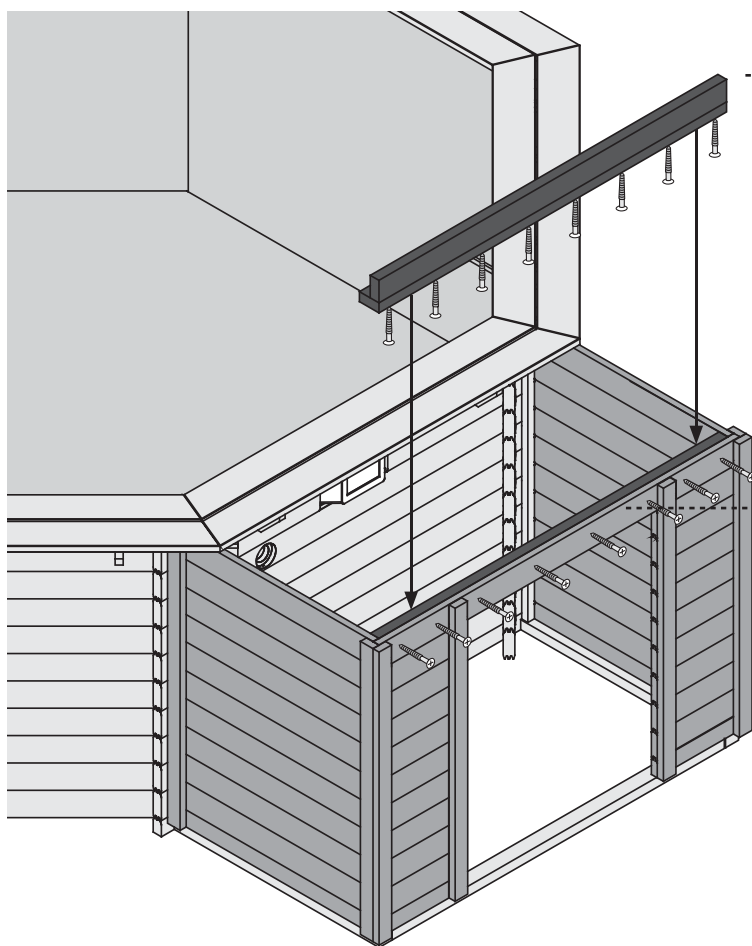
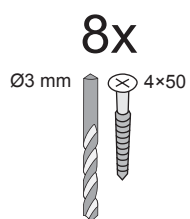
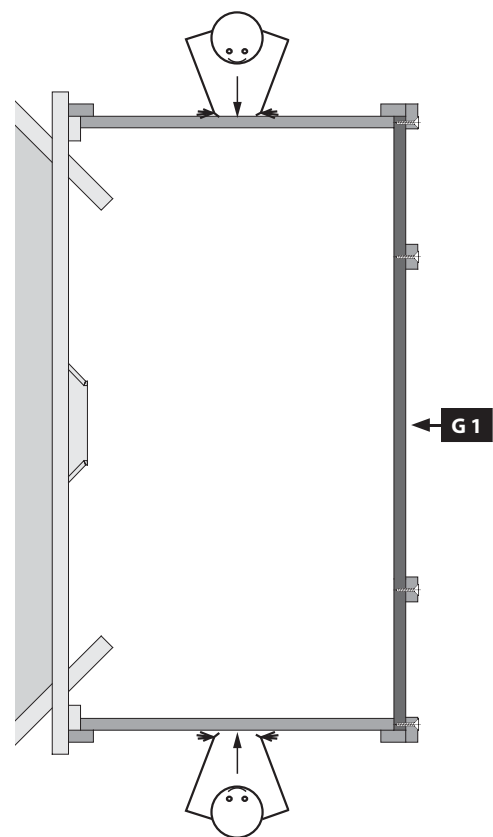
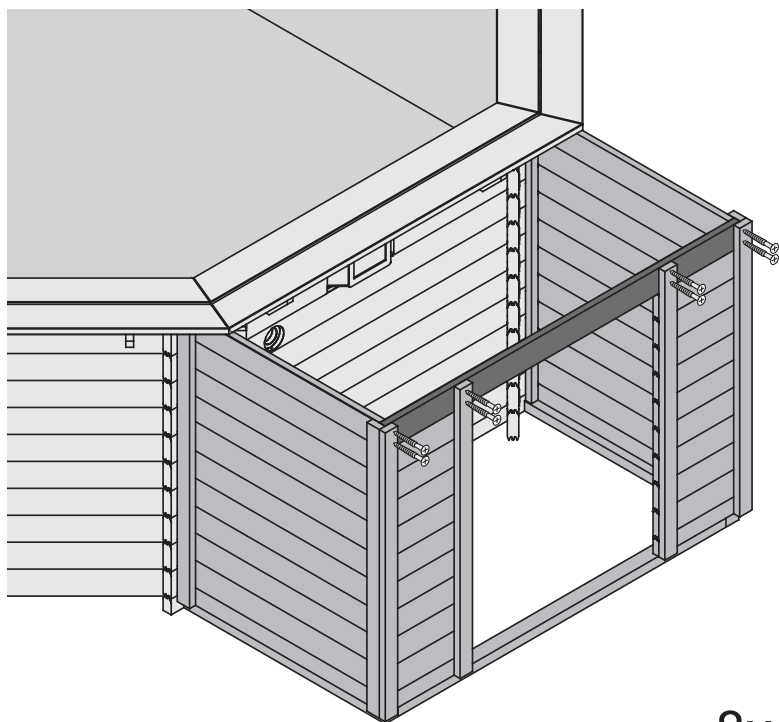

- | | | |
|--|--|--|
|  innen |  binnen |  dentro |
|  Inside |  inde |  uvnitř |
|  à l'intérieur |  dentro | |

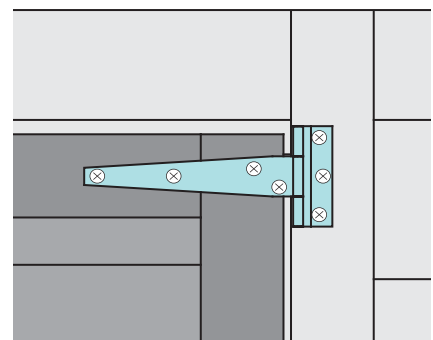
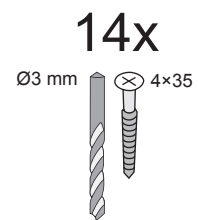
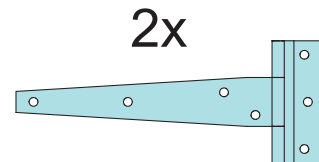
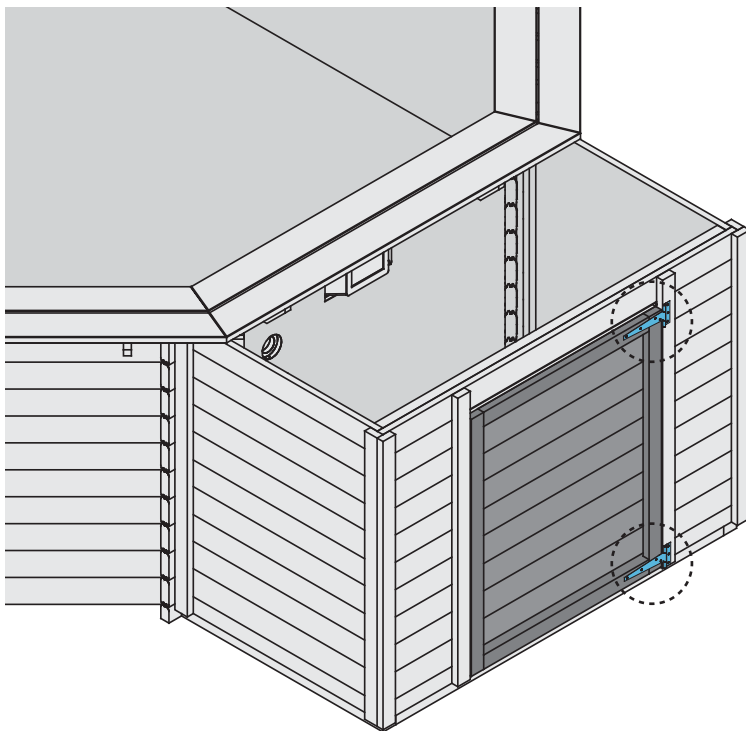
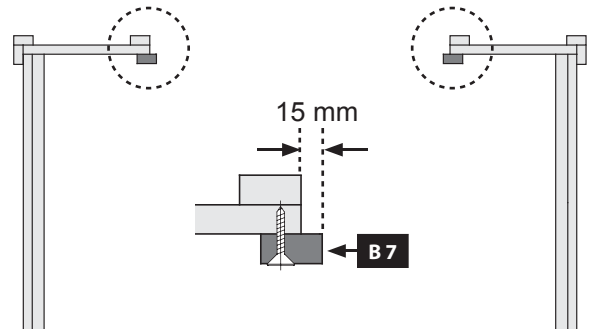
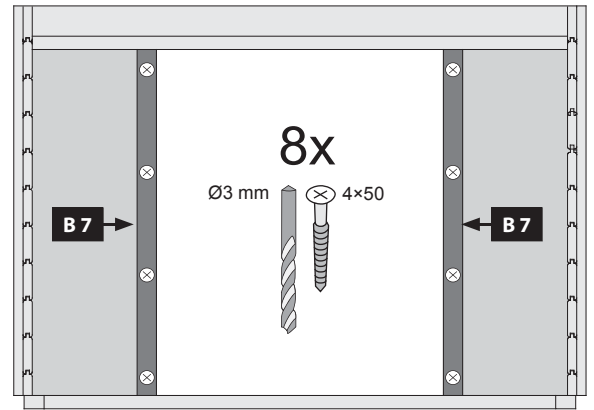
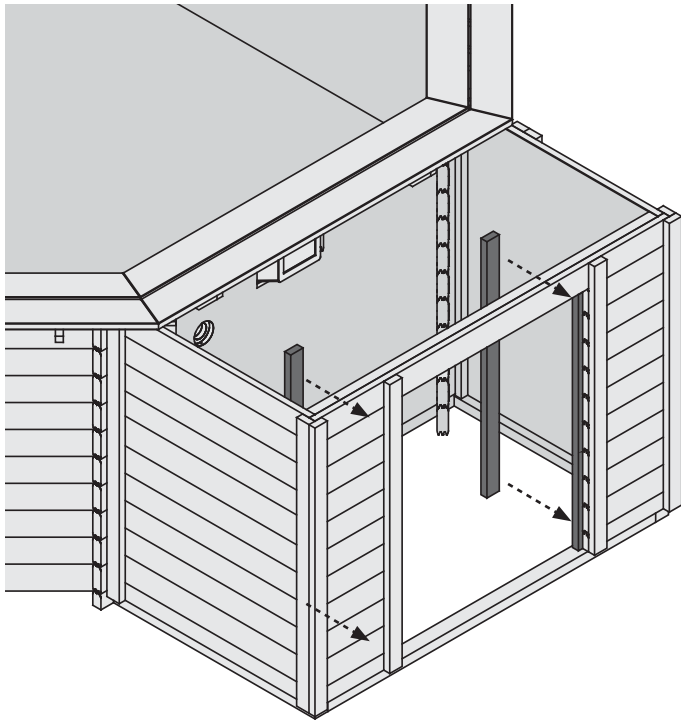

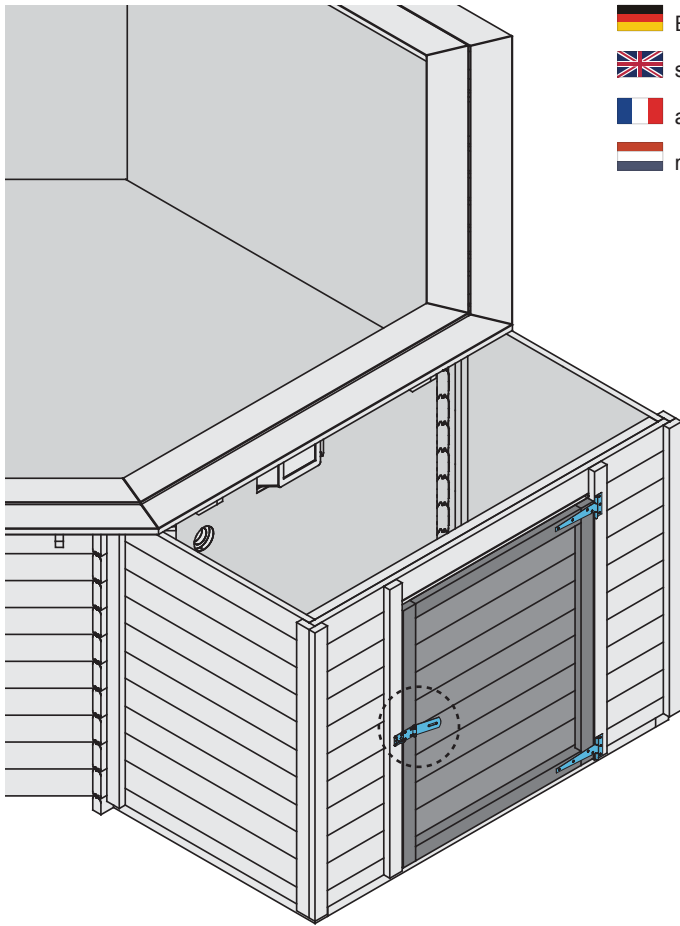

- Edelstahl
- stainless steel
- acier inoxydable
- roestvrij staal

- rustfrit stål
- acero inoxidable
- acciaio inossidabile
- nerez

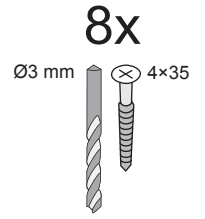

1.

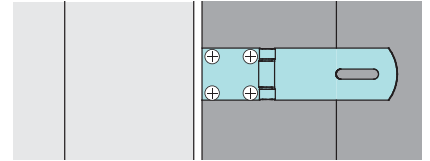

2.

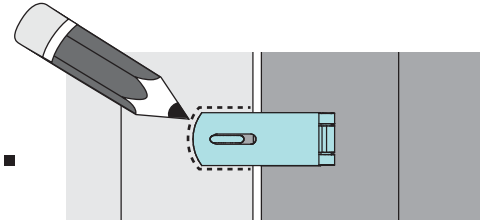

3.

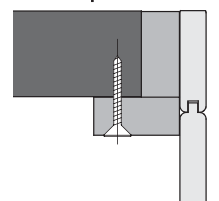
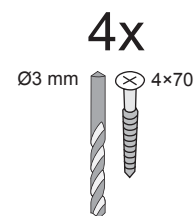
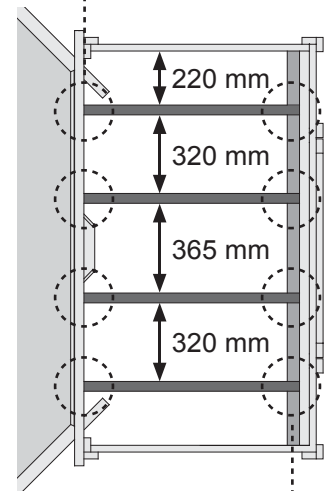
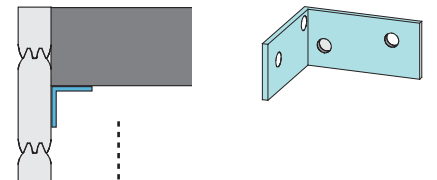
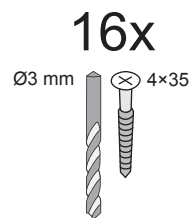
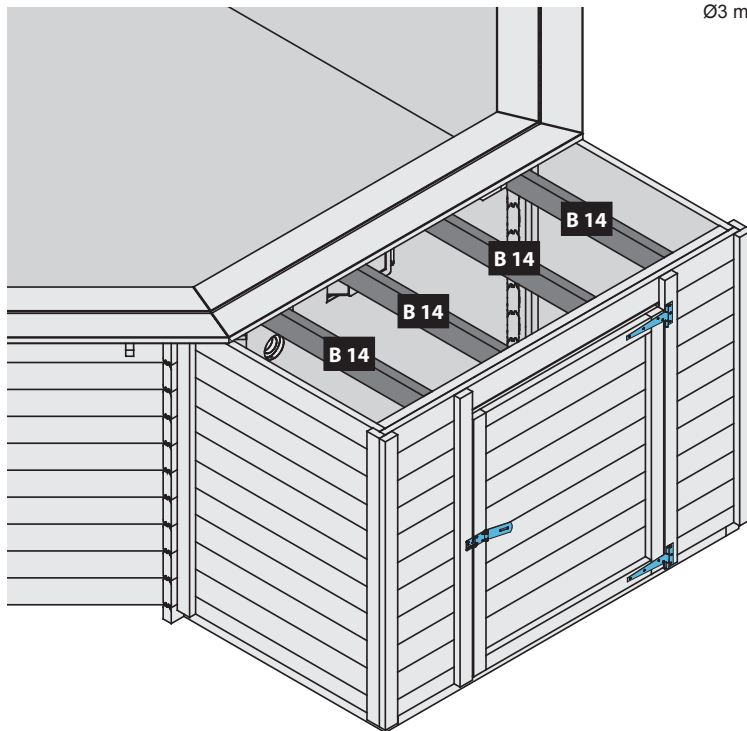
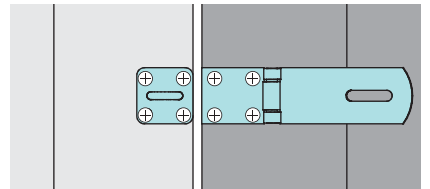

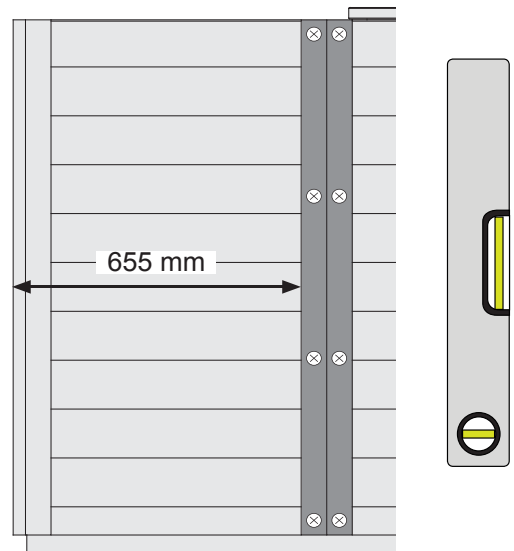
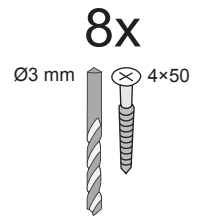
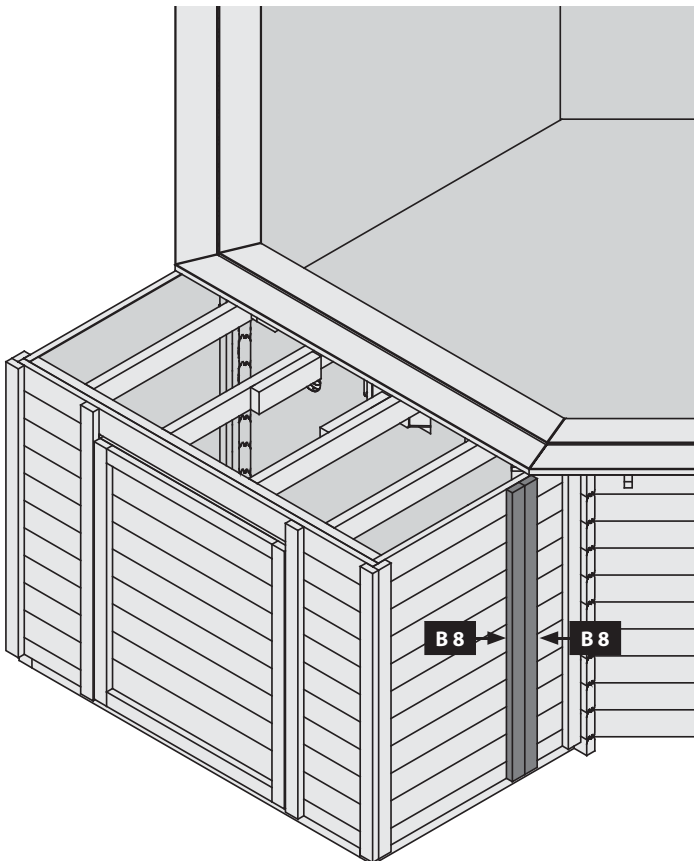
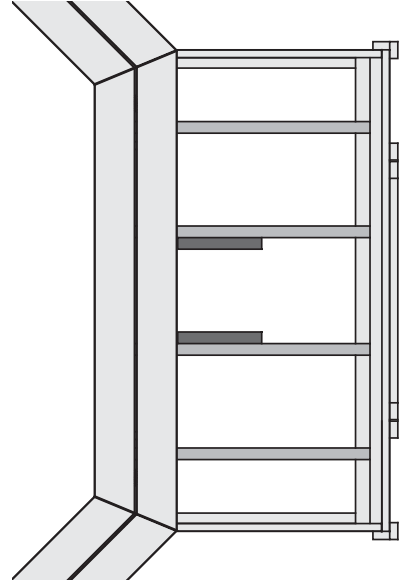
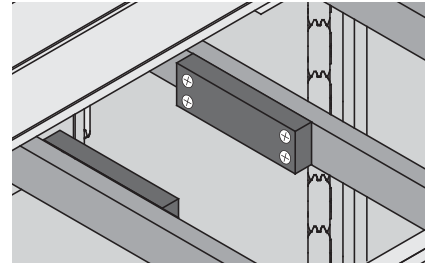
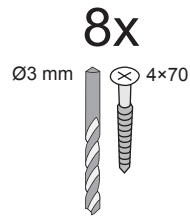
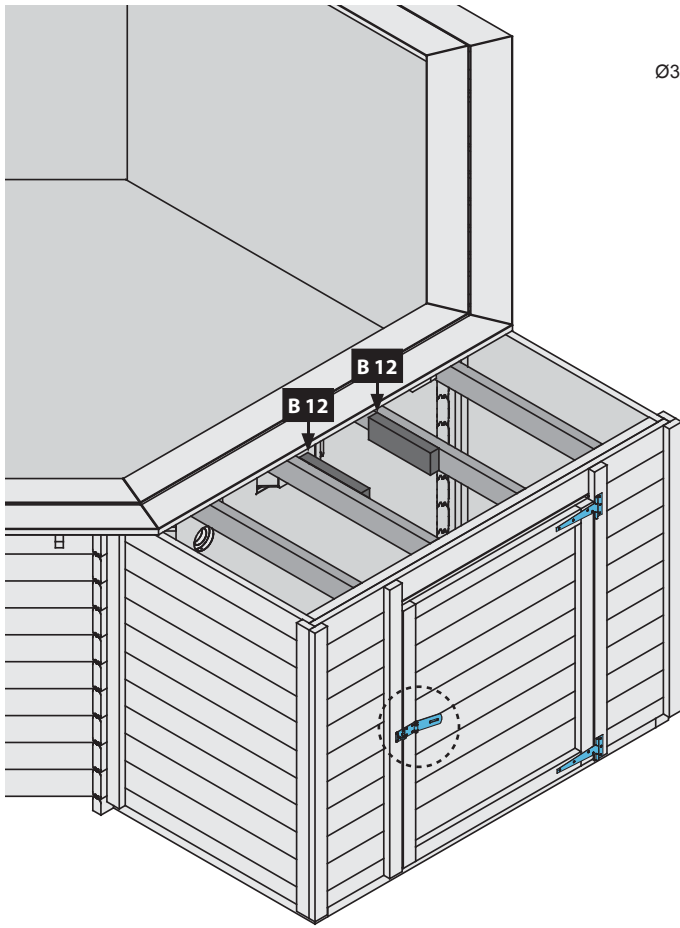

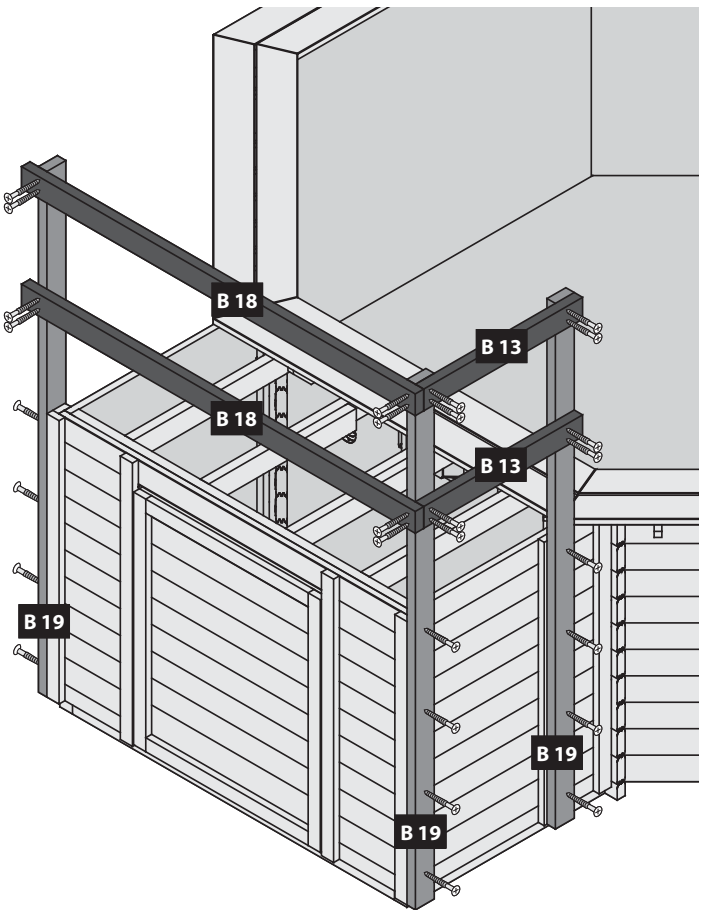

28x

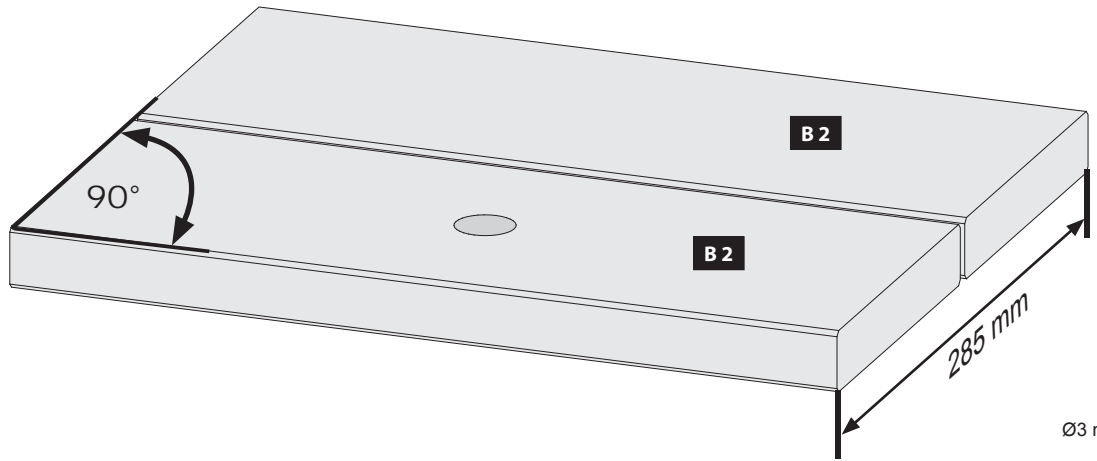
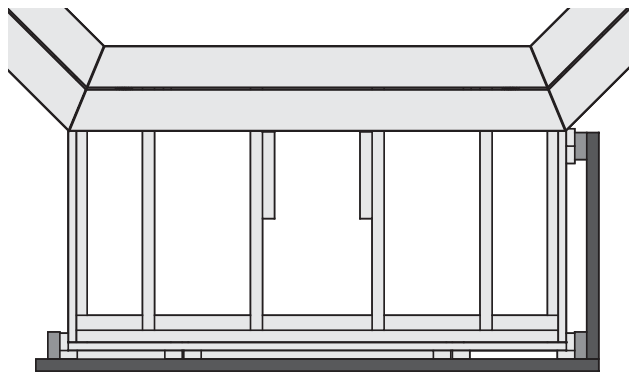
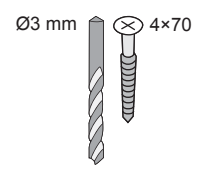

8x

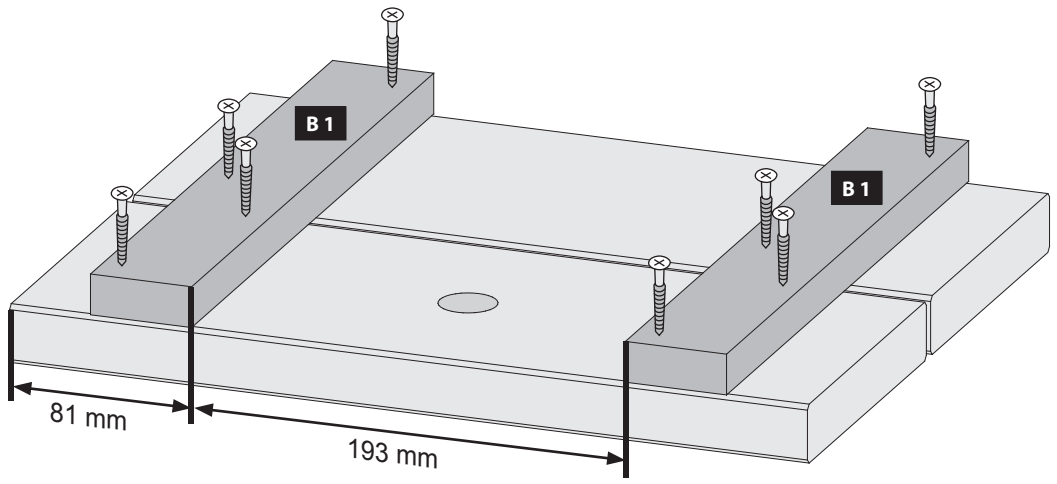
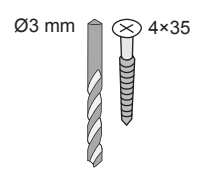

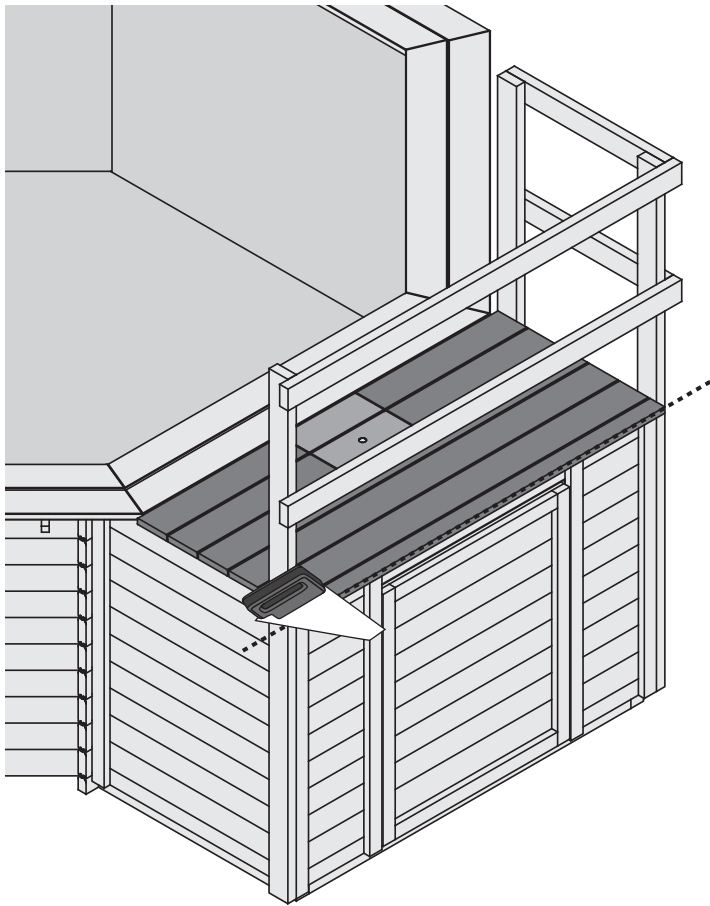

66x

Ø3 mm 4x50

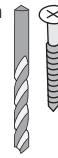

-  Edeldstahl
-  rustfrit stål
-  stainless steel
-  acero inoxidable
-  acier inoxydable
-  acciaio inossidabile
-  roestvrij staal
-  nerez

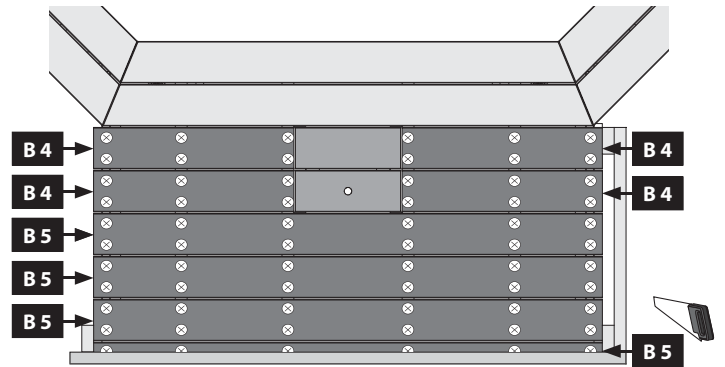

16x

Ø3 mm 4x50

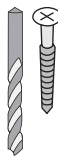

-  Edeldstahl
-  stainless steel
-  acier inoxydable
-  roestvrij staal
-  rustfrit stål
-  acero inoxidable
-  acciaio inossidabile
-  nerez

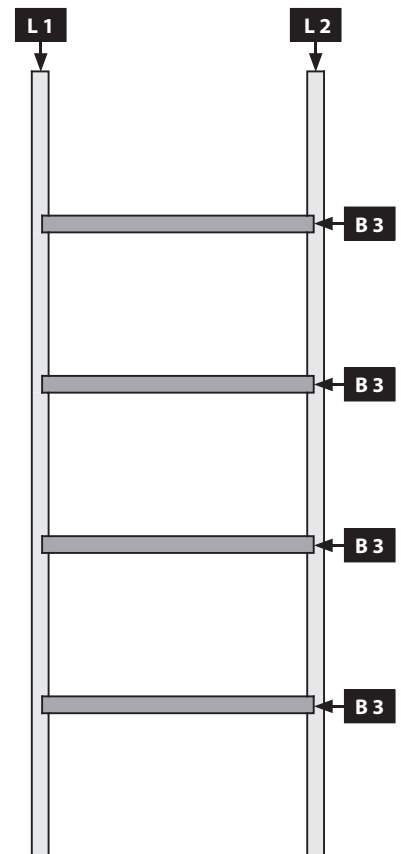
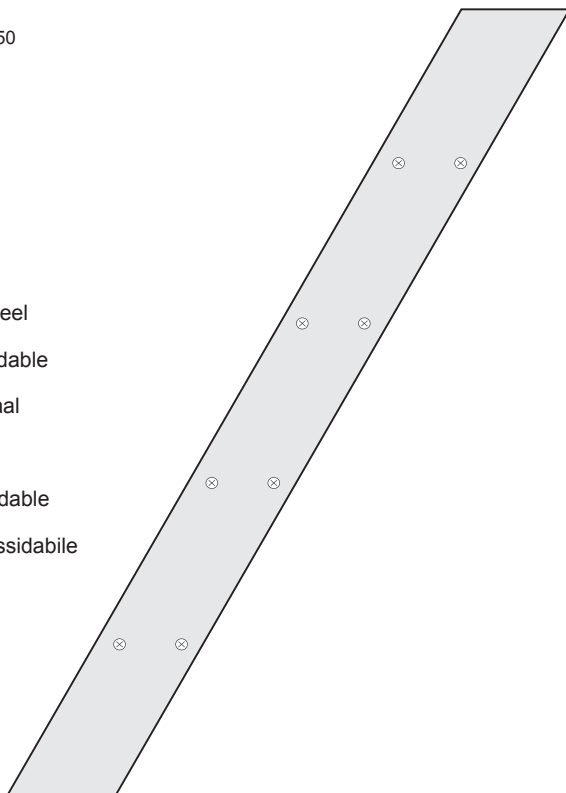

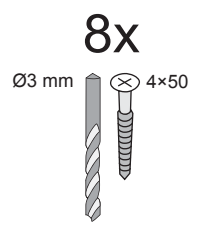
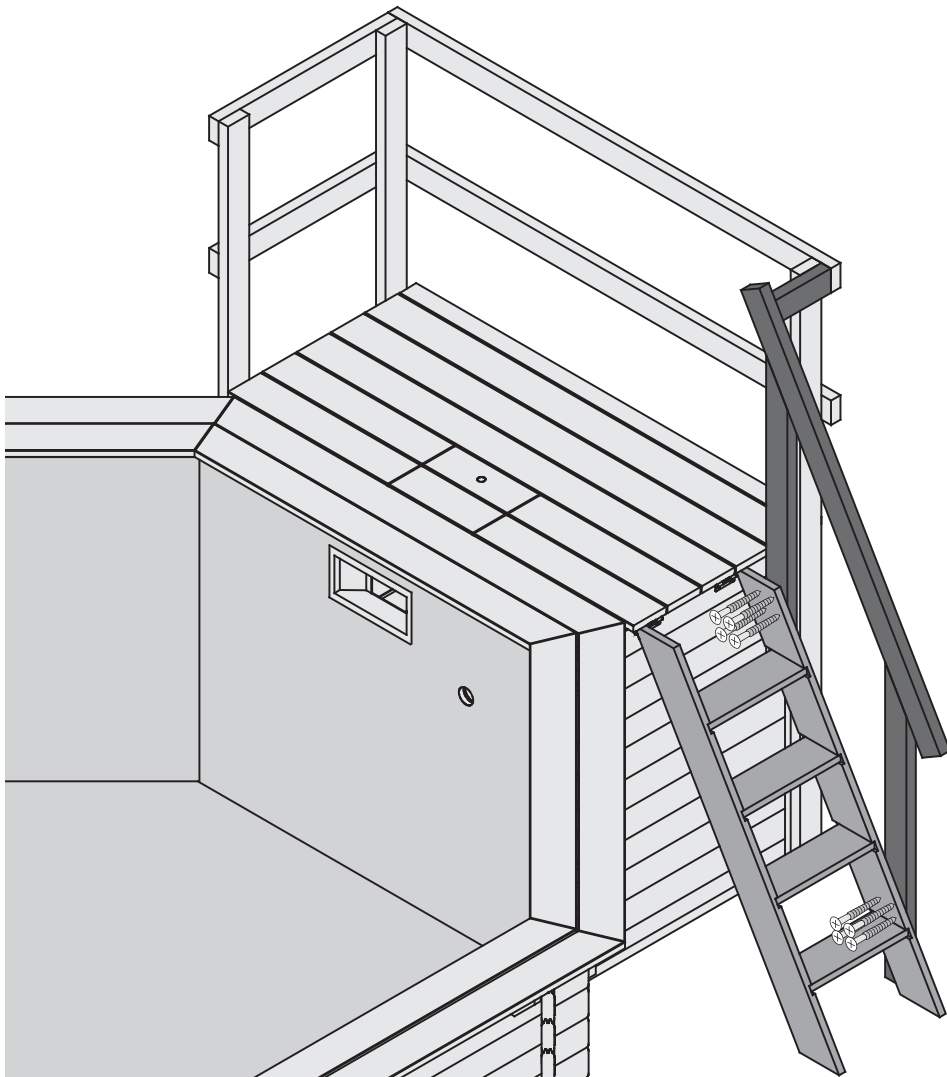
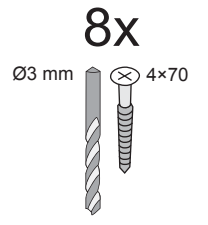
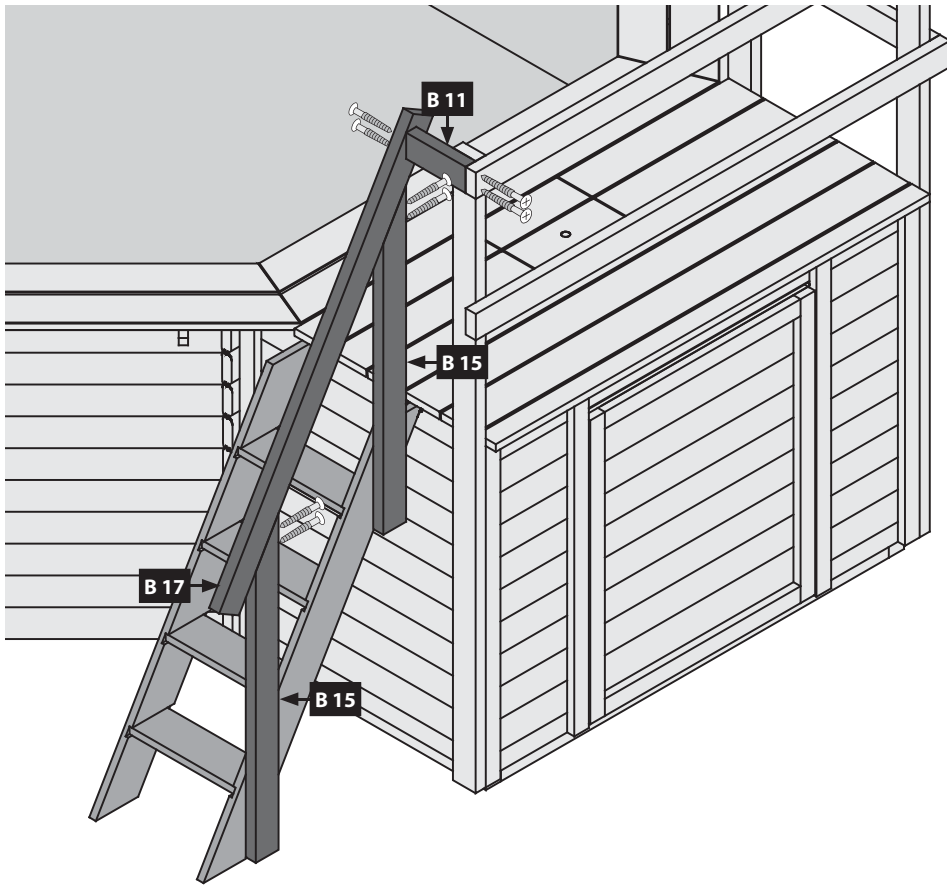

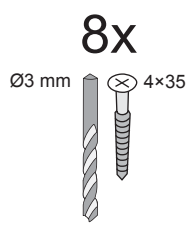
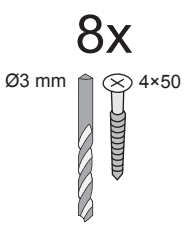
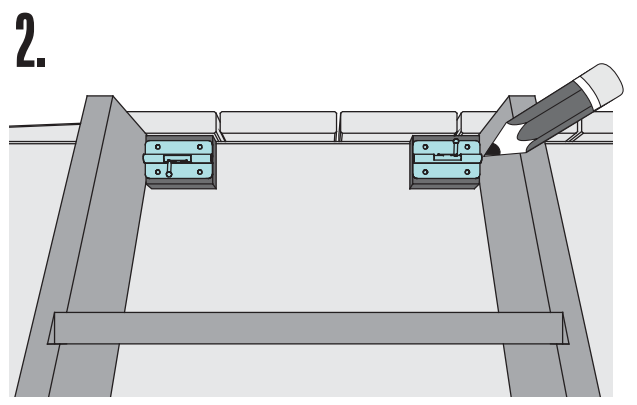
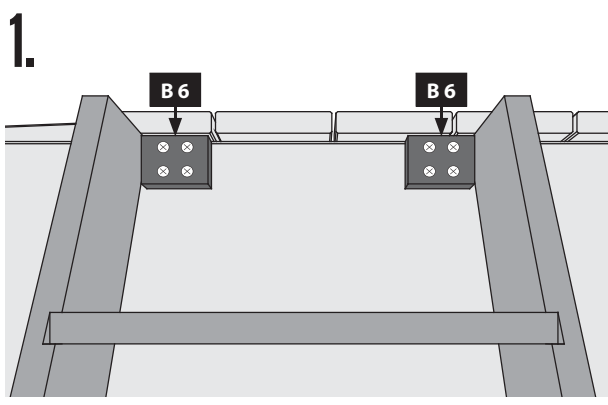
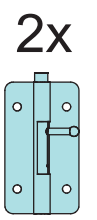
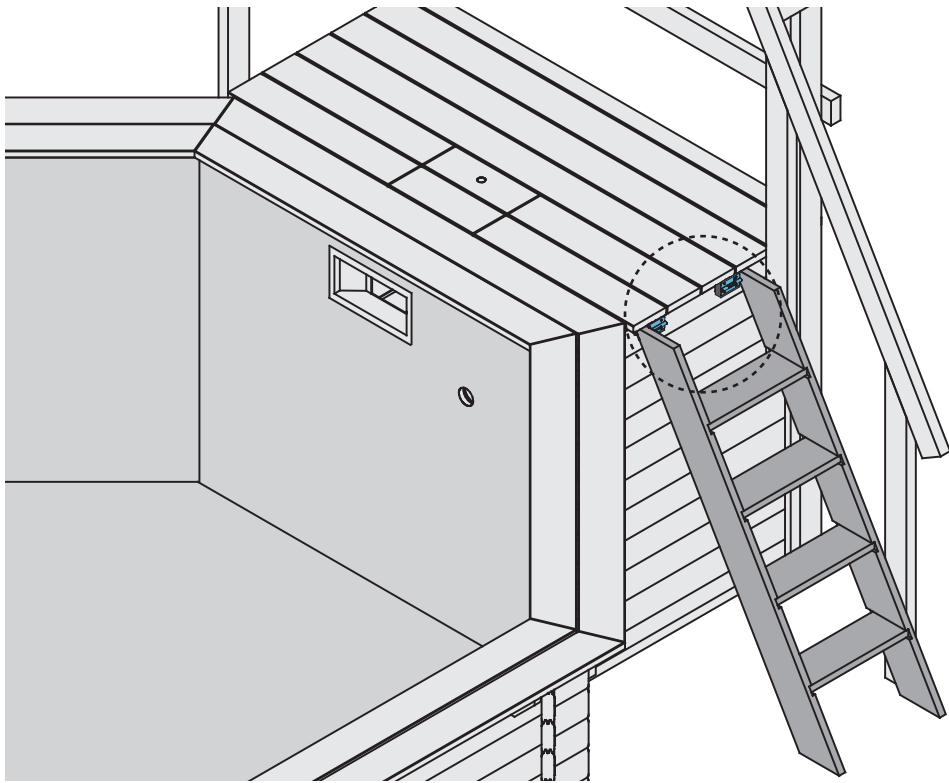

-  Edelstahl
-  stainless steel
-  acier inoxydable
-  roestvrij staal
-  rustfrit stål
-  acero inoxidable
-  acciaio inossidabile
-  nerez

