

31273 31274

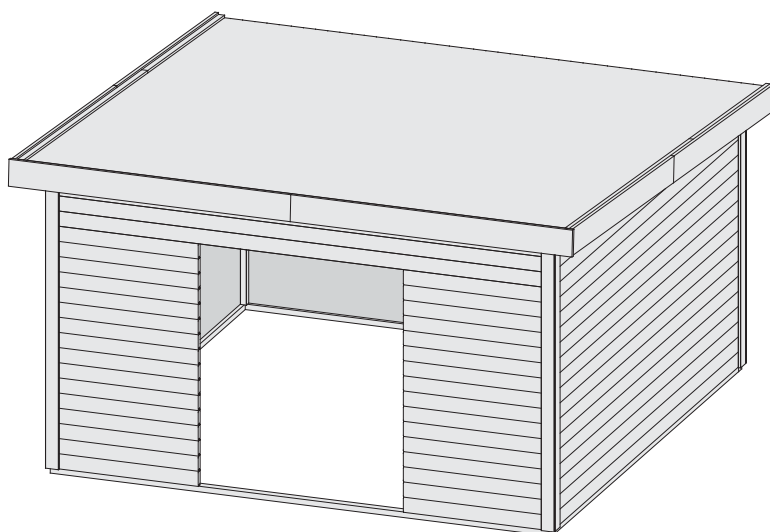

-  **Aufbauanleitung**
-  **Building Instructions**
-  **notice de montage**
-  **montagehandleiding**
-  **Montagevejledning**
-  **Instrucciones de construcción**
-  **Istruzioni per il montaggio**
-  **Montážní návod**

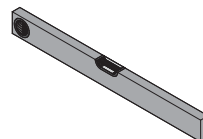
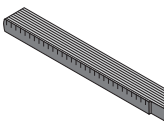
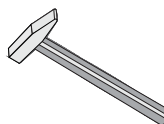
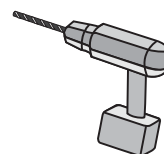
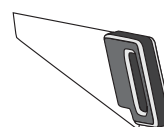

Bitte bewahren Sie die Anleitung und den Garantieschein zur Seriennummer auf.

Vernichten Sie diese erst nach Ablauf der Garantiezeit.

Eventuelle Beanstandungen können mithilfe der Stückliste einfacher zugeordnet werden.





Beigelegte Dokumente

- Informationsheft
- Garantieschein zur Seriennummer
- Typenschild inkl. Warnhinweise (Sauna)
- ggf. Zubehör-Anleitungen in externen Paketen

- *  Nicht im Lieferumfang enthalten
 Not included
 Non comprises dans la livraison
 Niet bijgeleverd

-  No forman parte del suministro
 Non incluso
 V ceně není zahrnuto
 Ikke inkluderet

- 1  Länge muss ermittelt und zugesägt werden
 Length must be determined and sawn
 La longueur doit être déterminée et sciée
 De lengte moet worden bepaald en worden gezaagd

-  La longitud debe ser determinada y aserrada
 La lunghezza deve essere determinata e segata
 Délka musí být určena a rozřezána
 Længden skal bestemmes og saves

- 2  Nicht gebraucht
 Not needed
 Pas nécessaire
 Niet nodig

-  No es necesario
 Non necessario
 Není nutná
 Ikke nødvendigt





- 3  Mit Zubehör
 With accessories
 Avec accessoires
 Met toebehoren

-  Con accesorios
 Con accessori
 S příslušenstvím
 Med tilbehør

- 4  Fixiert vorübergehend
 Fixed temporarily
 Temporairement fixe
 Tijdelijk vast

-  Temporalmente fijo
 Temporaneamente fisso
 Dočasně pevný
 Midlertidigt rettet

- 5  Bestand vom Haus
 Inventory of the house
 Inventaire de la maison
 Inventaris van het huis

-  Inventario de la casa
 Inventario della casa
 Inventář domu
 Inventar af huset

Werkzeuge / Tools*

X

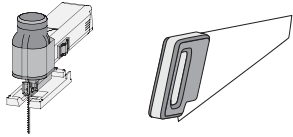

X

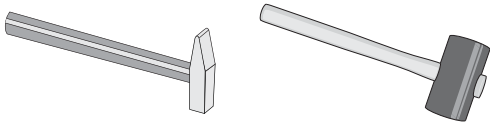

X



X



X

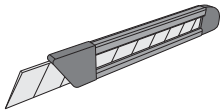

X



X

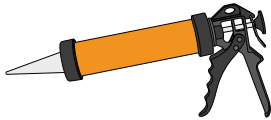

X

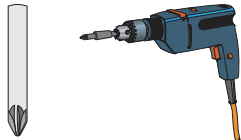

X

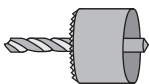
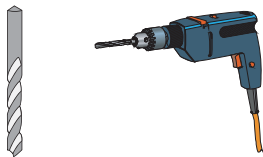

X

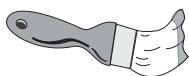

X





Vergleichen Sie zuerst die Material-liste mit Ihrem Paketinhalt! Bitte haben Sie Verständnis, dass Beanstandungen nur im nicht aufgebauten Zustand bearbeitet werden können!



Vergelijk eerst de lijst van materialen met de inhoud van uw pakket! Reclamaties kunnen alleen in behandeling worden genomen zolang de onderdelen nog niet zijn gemonteerd!



Confrontate questa distinta materiali prima con il contenuto del pacchetto! Vi preghiamo di comprendere che eventuali reclami possono essere accolti solo prima del montaggio!



First compare the list of materials with your package contents! Please understand that complaints can be processed in the non-built status only!



Start med at kontrollere materialelisten med indholdet af den leverede pakke! Vi gør venligst opmærksom på at reklamationer kun kan behandles for materialer som ikke er blevet bearbejdet!



Nejprve přezkontrolujte obsah balení podle materiálového listu! Mějte pochopení pro to, že případnou reklamaci se můžeme zabývat pouze tehdy, když díly nebudou smontované! Za pomoci tohoto seznamu můžete jednotlivé díly přiřadit k montážnímu návodu.



Commencez par comparer la liste du matériel avec le contenu de votre paquet! Sachez que nous traitons uniquement les réclamations concernant le matériel à l'état non monté!



En primer lugar, compare la lista de material con el contenido del paquete. Rogamos entienda que las reclamaciones sólo pueden ser tramitadas antes de montar el objeto!

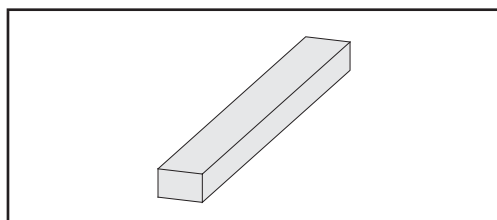
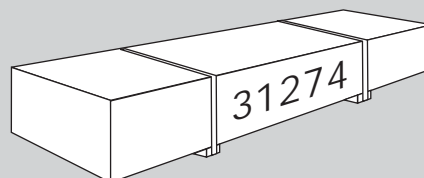
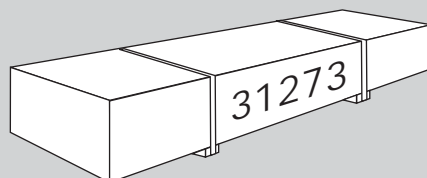

10 x B1	2380 x 45 x 18 mm	ID 16368
39 x B2	180 x 140 x 26 mm	ID 56910
4 x B3	1950 x 190 x 26 mm	ID 53145
2 x B4	2040 x 190 x 26 mm	ID 78730
12 x B5	3570 x 190 x 26 mm	ID 68942
12 x B6	200 x 38 x 38 mm	ID 69082
4 x B7	3630 x 60 x 40 mm	ID 67909
6 x B8	2230 x 45 x 45 mm	ID 60415

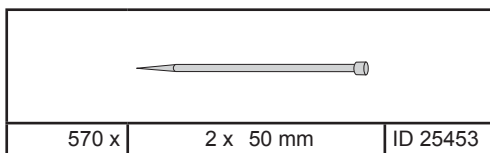

570 x	2 x 50 mm	ID 25453
-------	-----------	----------

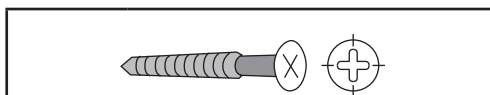

50 x	4 x 30 mm	ID 3686
130 x	4 x 35 mm	ID 3687
220 x	4 x 50 mm	ID 3688
430 x	4 x 70 mm	ID 3689
50 x	4,5 x 80 mm	ID 9204

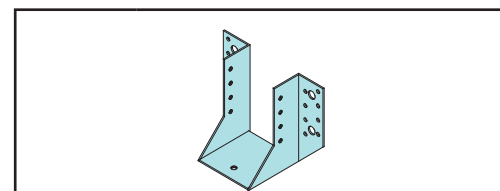

8 x	ID 33143
-----	----------

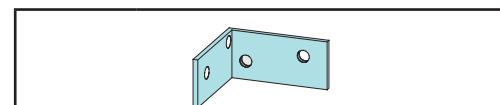

8 x	ID 21208
-----	----------

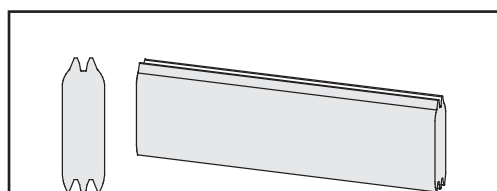

32 x W1	1043 x 121 x 40 mm	ID 21381
61 x W2	3570 x 121 x 40 mm	ID 67847

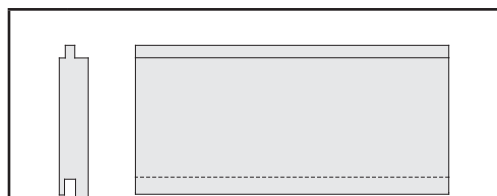

46 x R1	3900 x 96 x 19 mm	ID 19573
---------	-------------------	----------

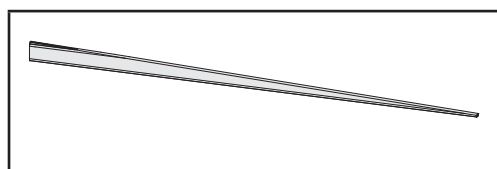

2 x G1	3570 x 121 x 40 mm	ID 31276
--------	--------------------	----------

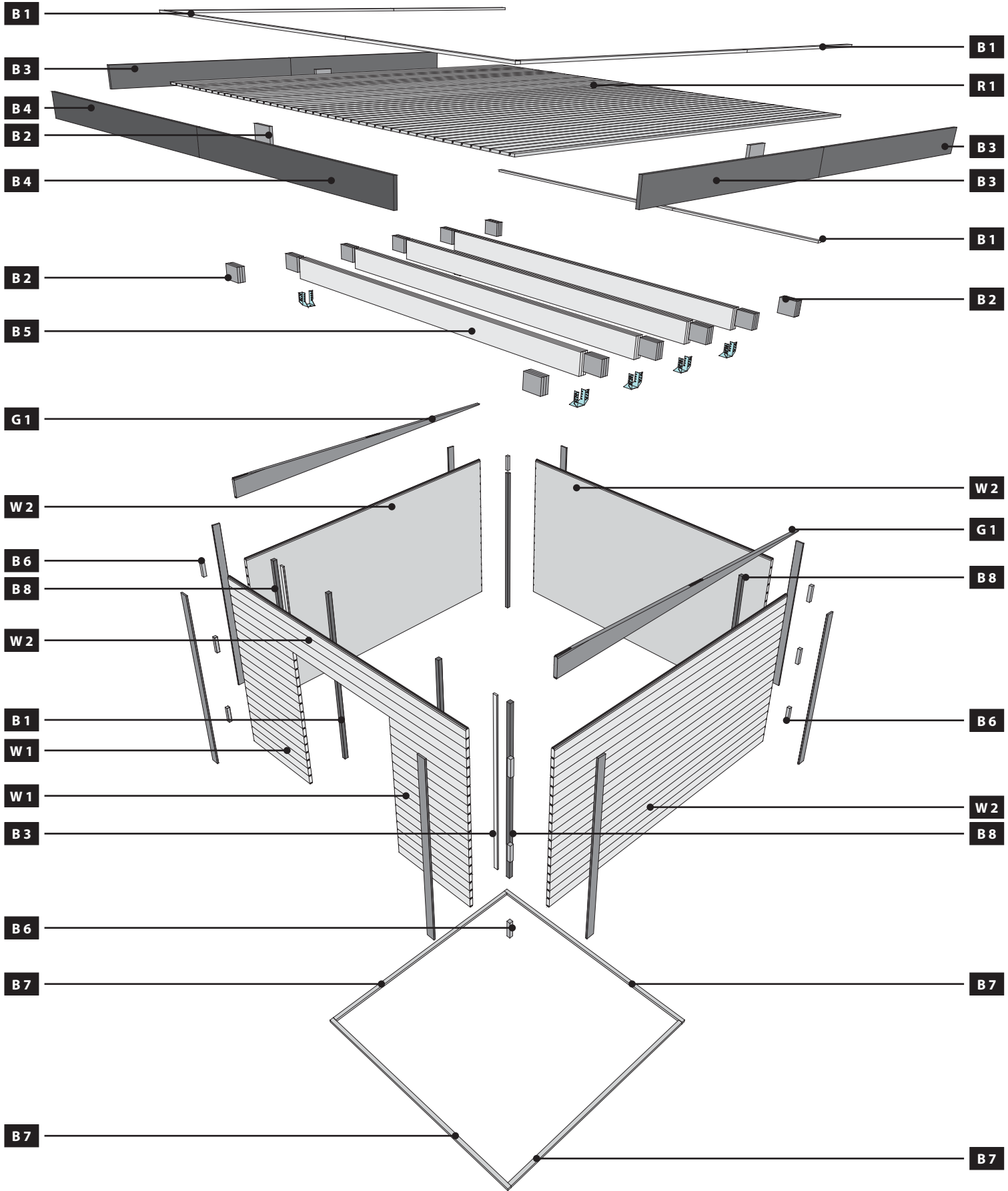

01

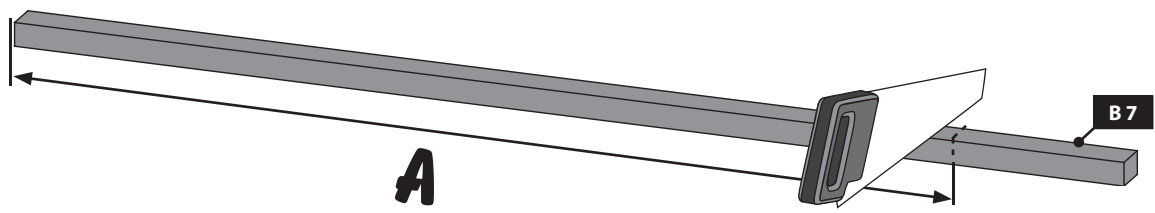

02

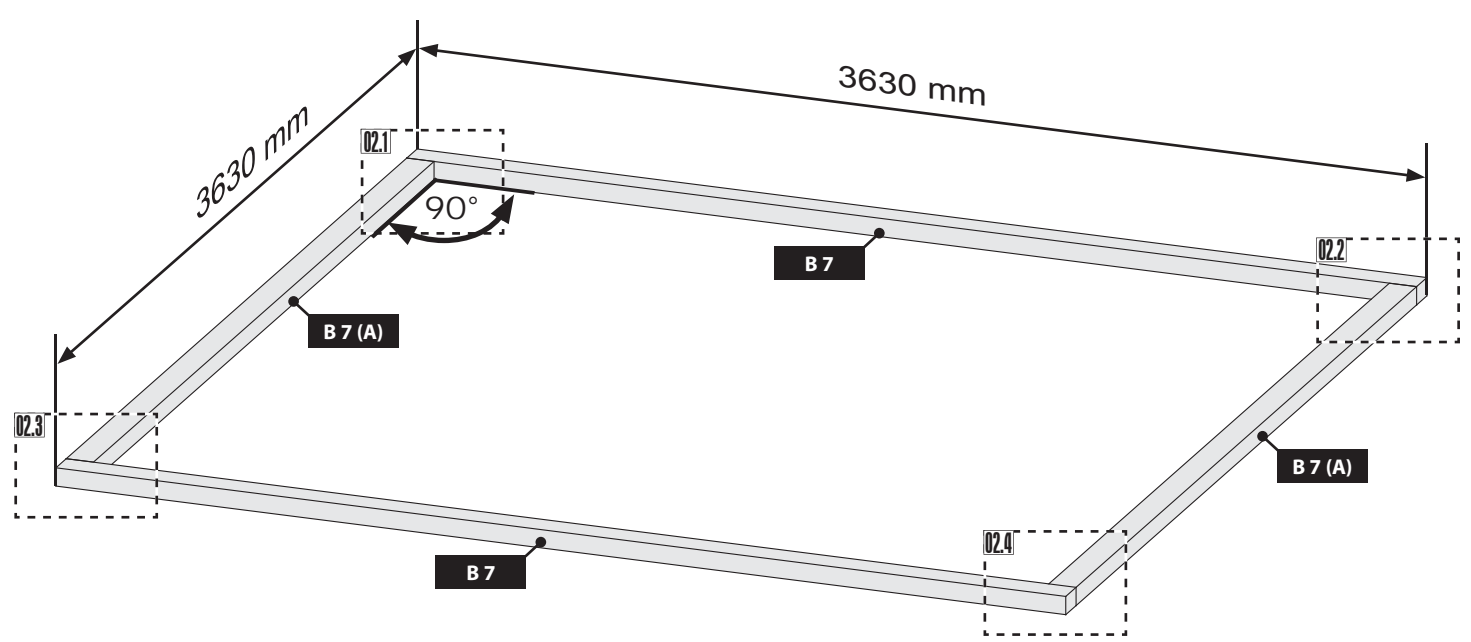
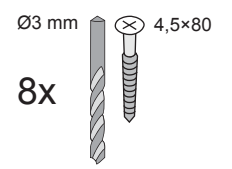

02.1

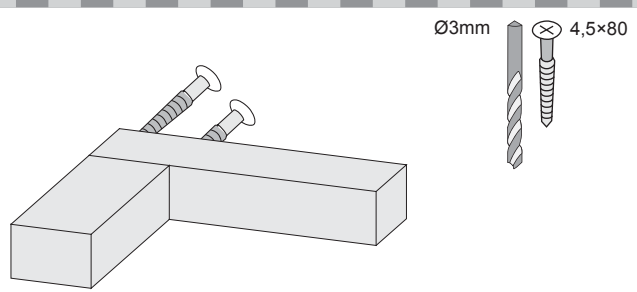

02.2

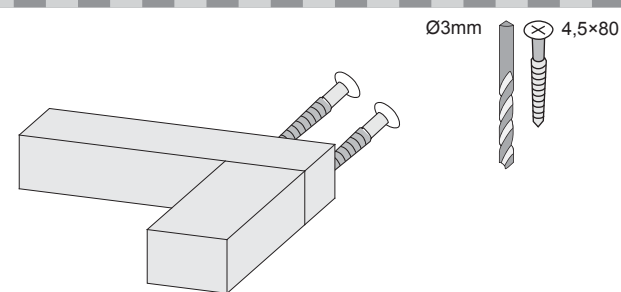

02.3

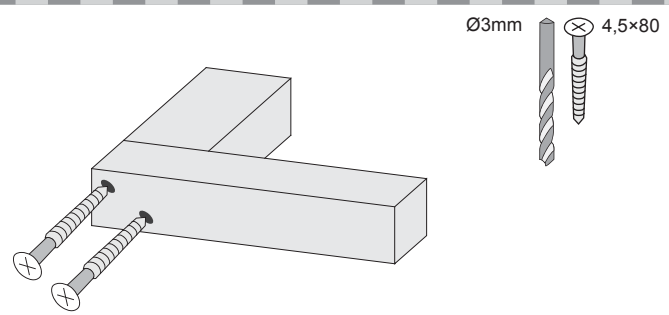

02.4

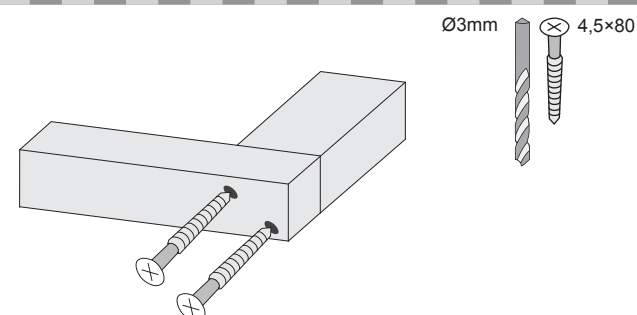

8x

32x

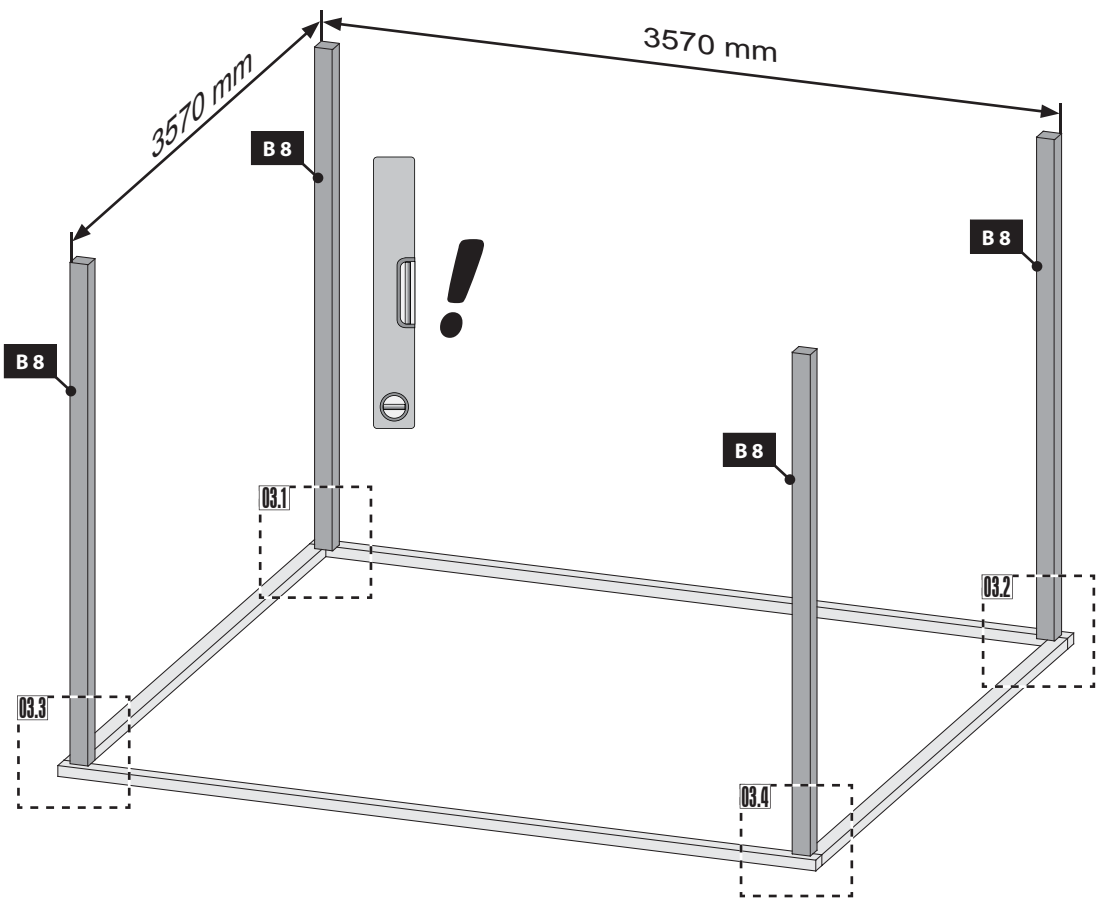
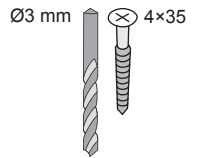
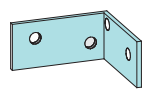

03.1

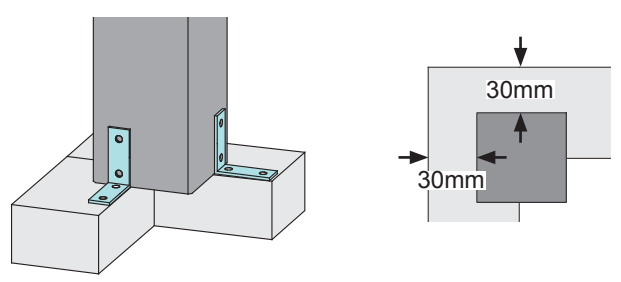

03.2

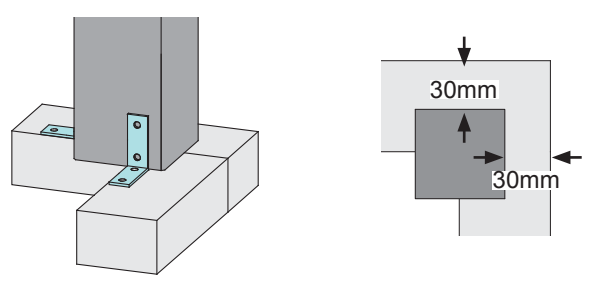

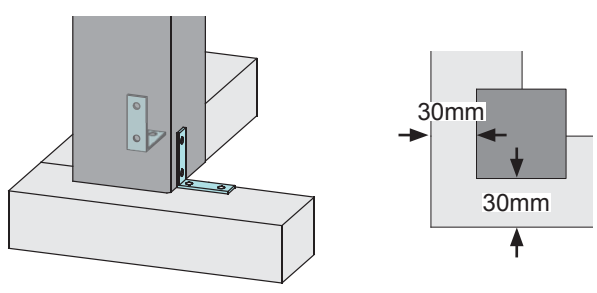

03.3

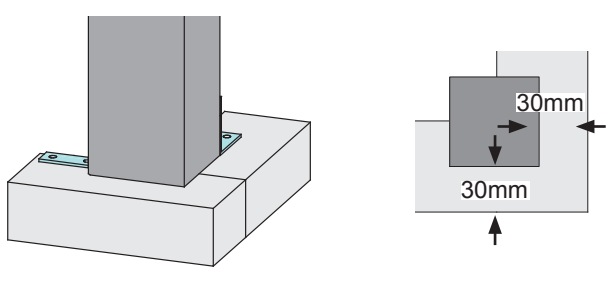

03.4



 Leim! Achten Sie auf die gleiche Höhe

 Glue! Look for the same height

 Colle! Faites attention à la même hauteur

 Lijm! Besteed aandacht aan de dezelfde hoogte

 Lim! Vær opmærksom på samme højde

 Pegamento! Prestar atención a la misma altura

 Colla! Prestare attenzione alla stessa altezza

 Klíh! Dávejte pozor na stejnou výšku

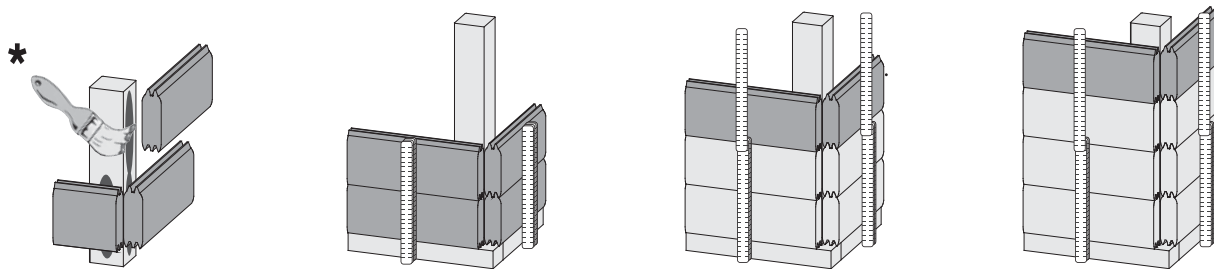

04

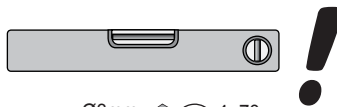

216x

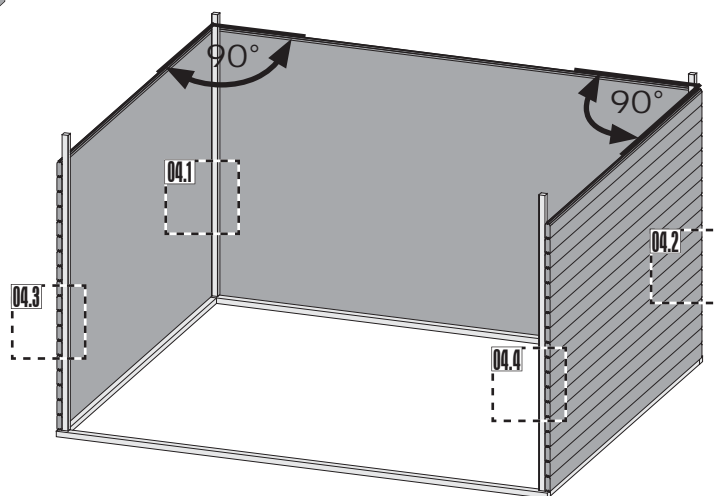
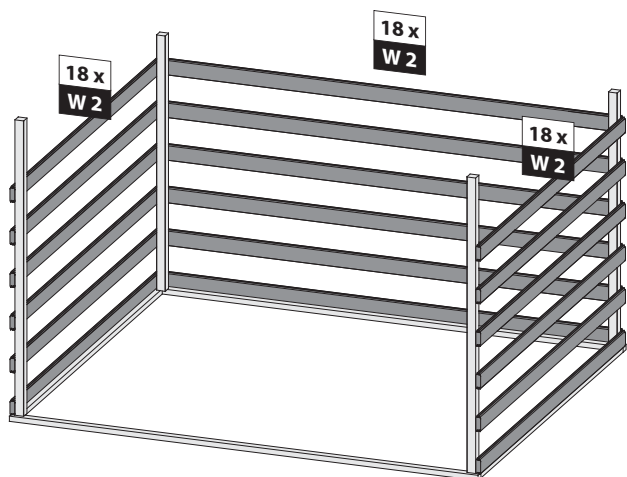

04.1

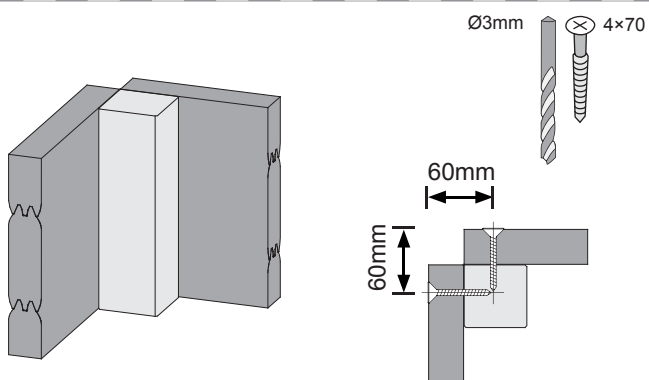

04.2

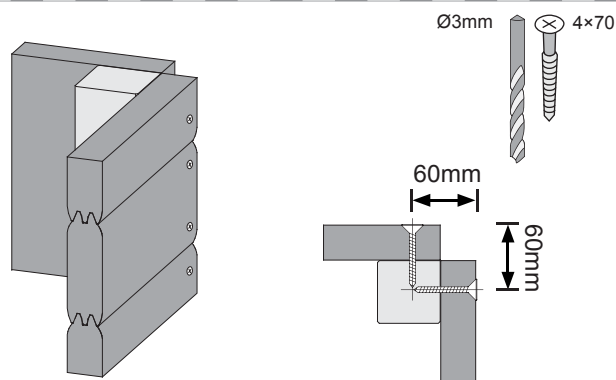



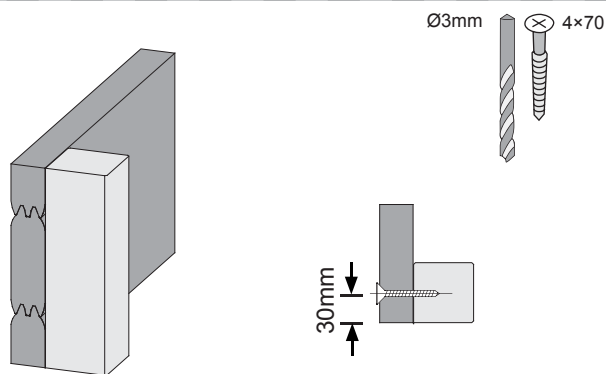

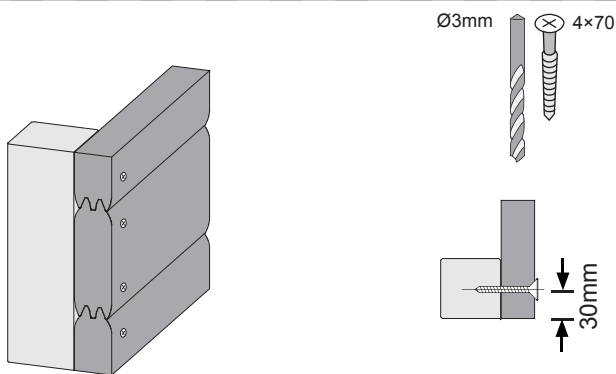

04.3





04.4



 Leim! Achten Sie auf die gleiche Höhe
 Glue! Look for the same height
 Colle! Faites attention à la même hauteur

 Lijm! Besteed aandacht aan de dezelfde hoogte
 Lim! Vær opmærksom på samme højde
 Pegamento! Prestar atención a la misma altura

 Colla! Prestare attenzione alla stessa altezza
 Klíh! Dávejte pozor na stejnou výšku

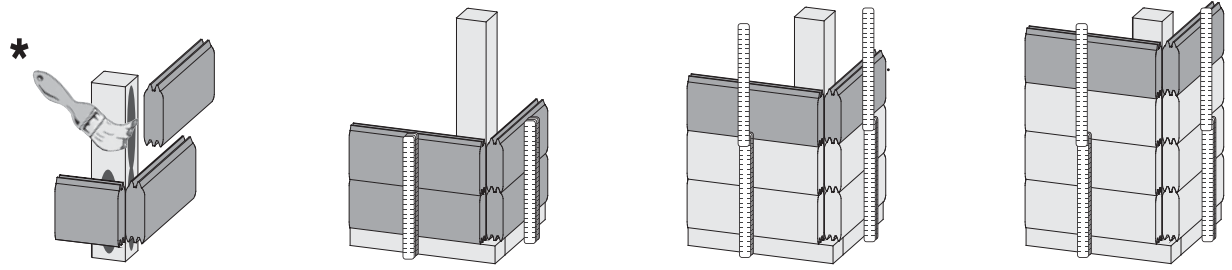

05

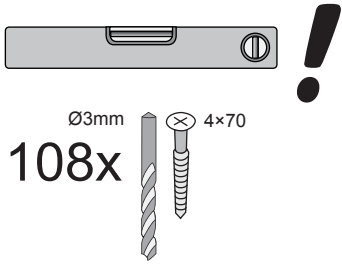

108x

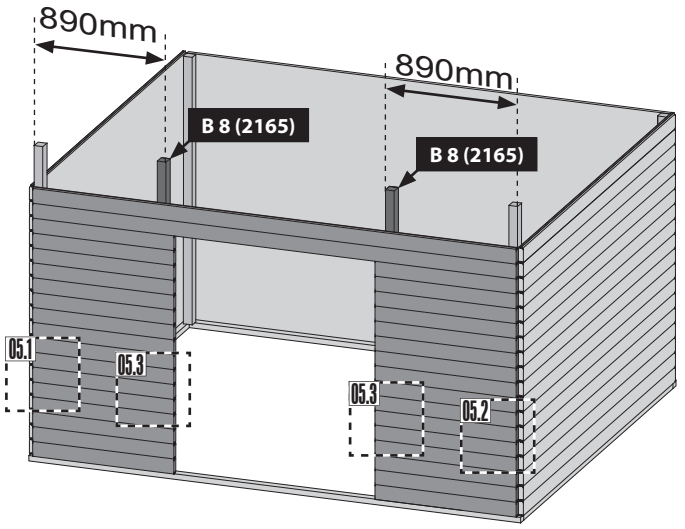
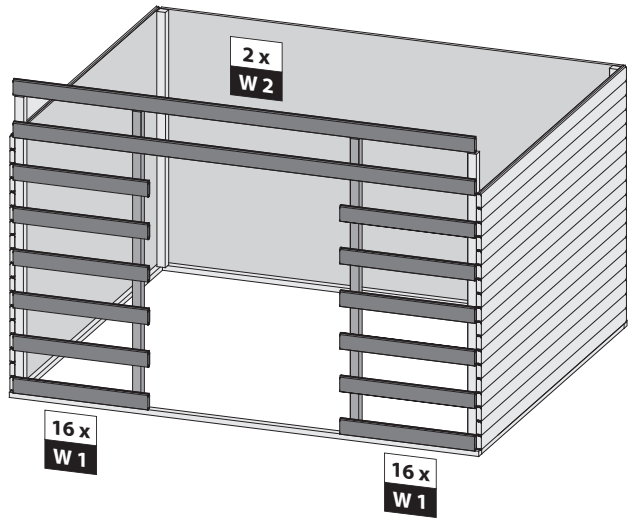

05.1

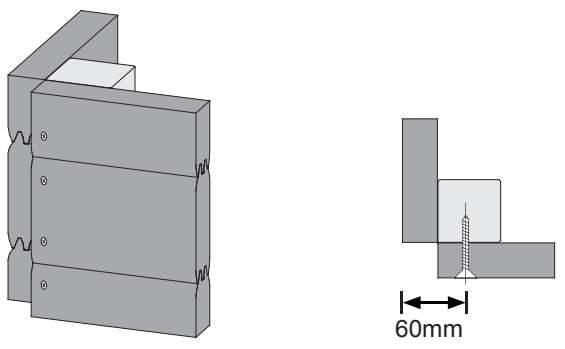

05.2

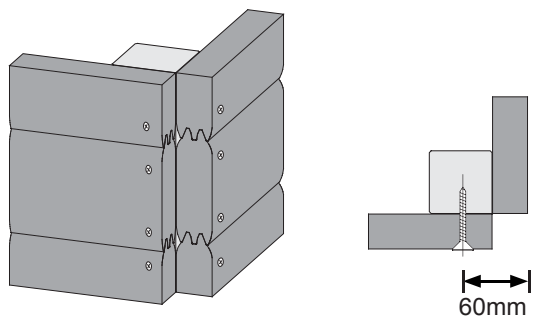

05.3

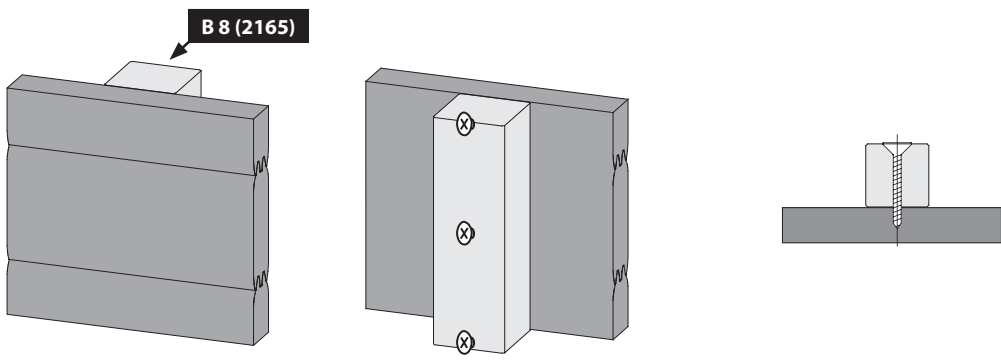

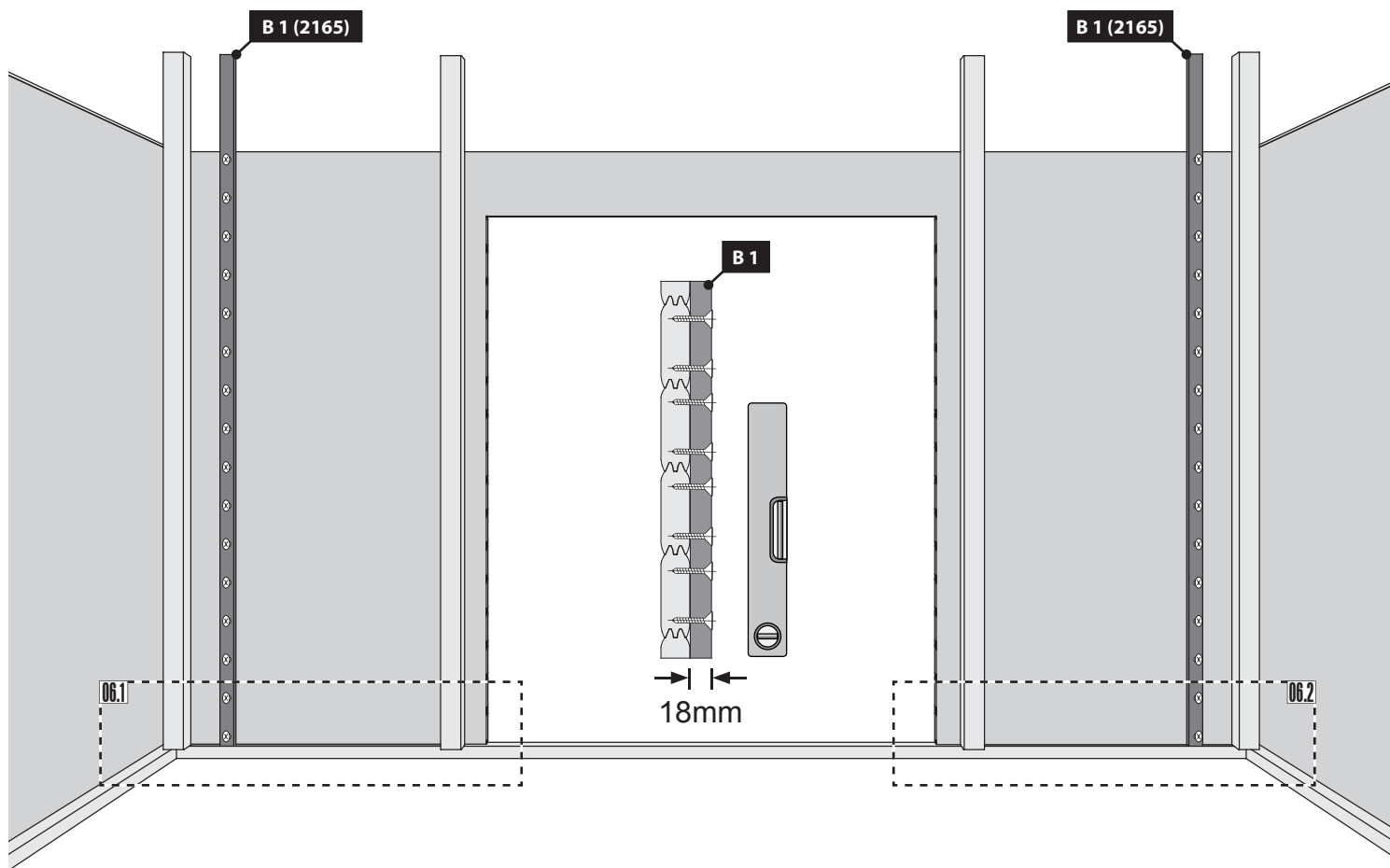
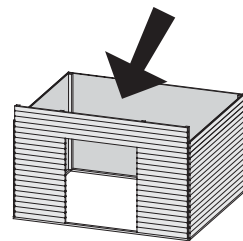
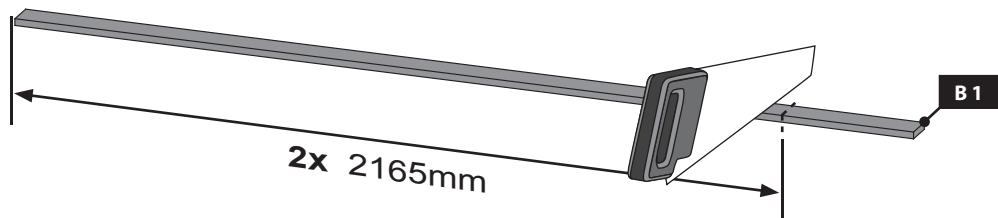

06.1

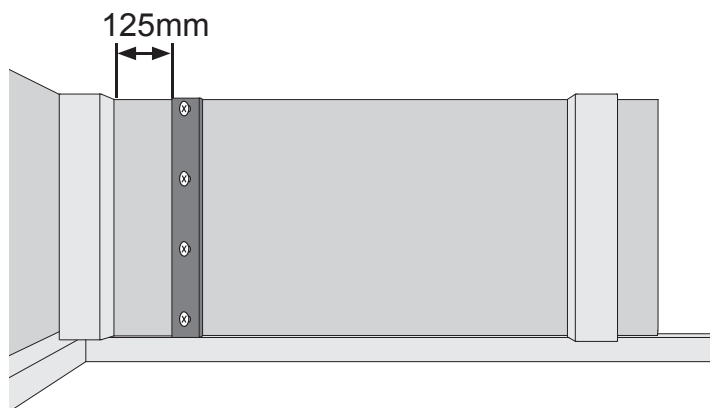
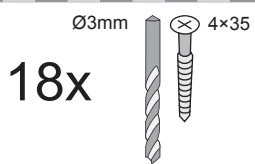

06.2

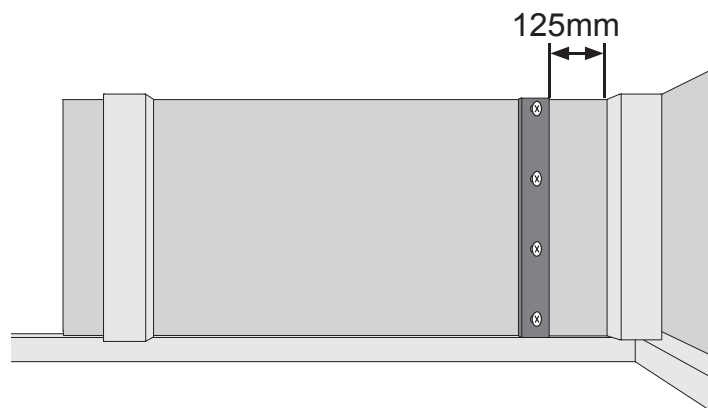
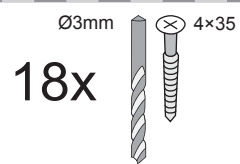

Ø3mm 4x50
2x

Ø3mm 4x70
12x

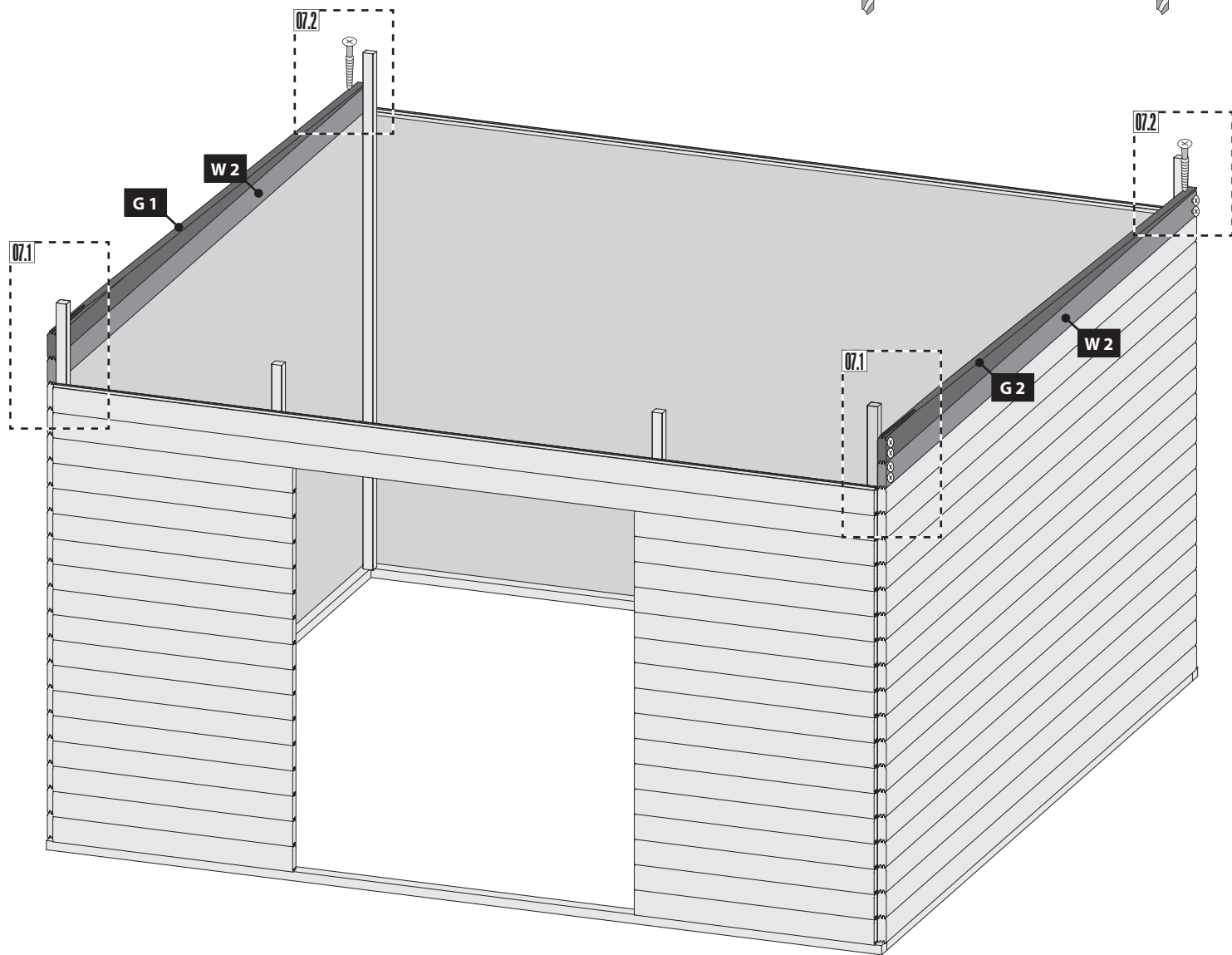

07.1

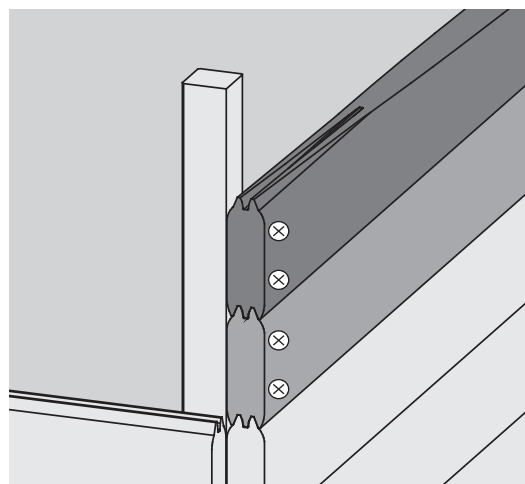

07.2

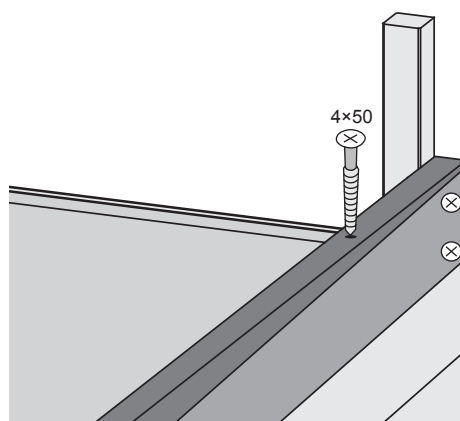

-  Bündig!
-  Flush!
-  Affleurement!
-  Gelijk!
-  I flugt!
-  Aras!
-  Combacia!
-  Stejný!

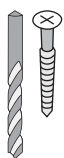
Ø3mm 4x70
12x 

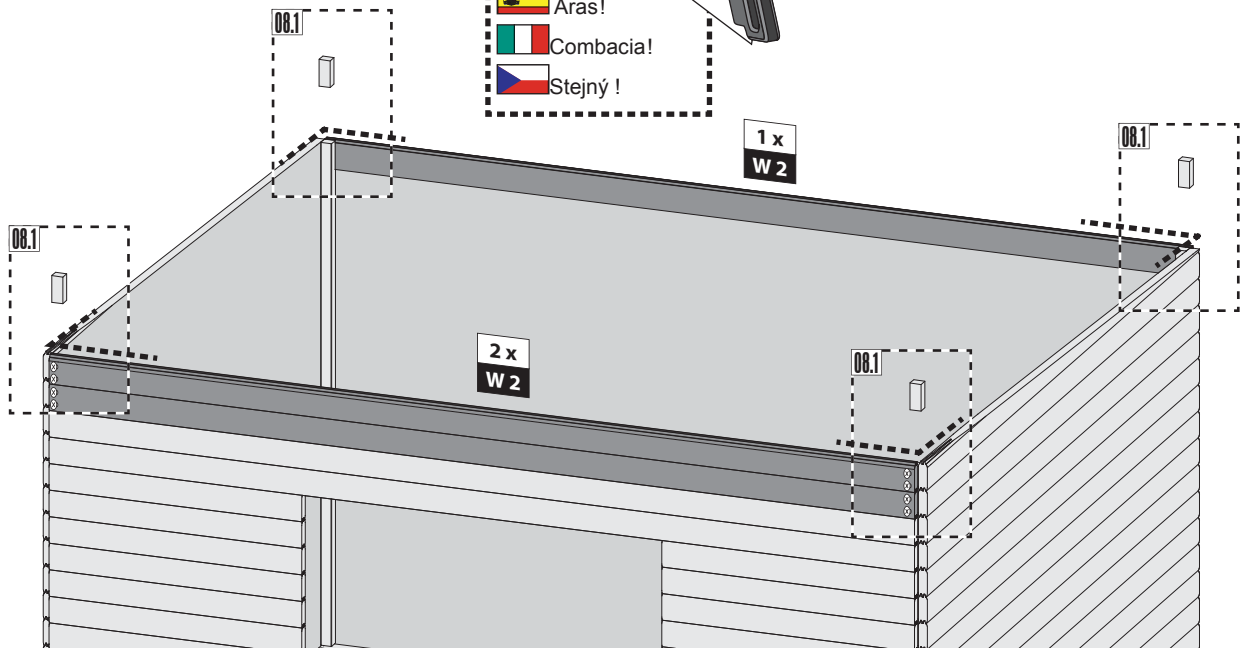

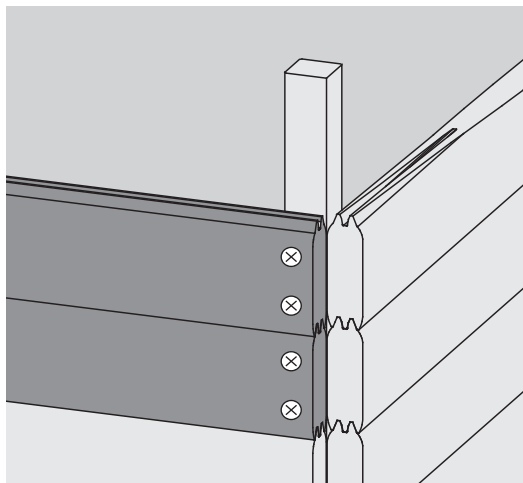

08.1-1



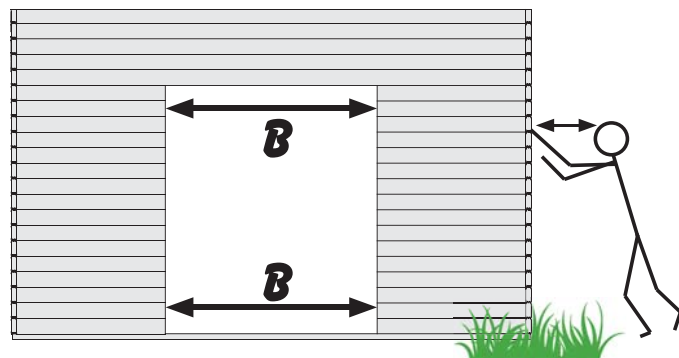
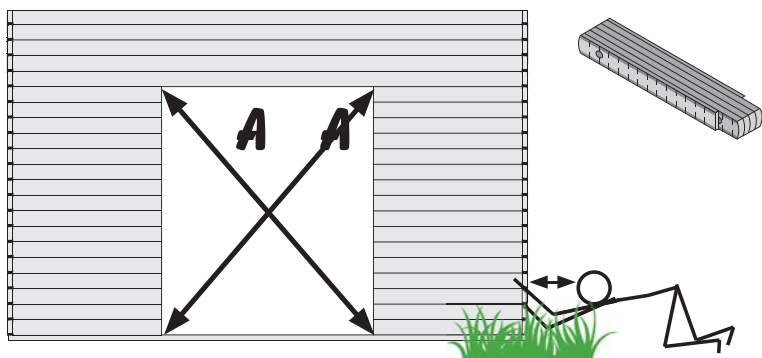
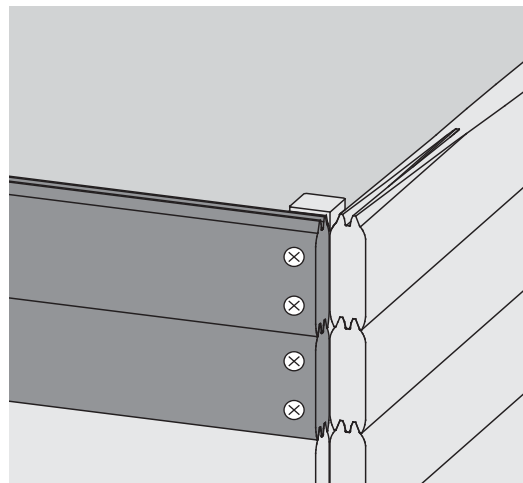

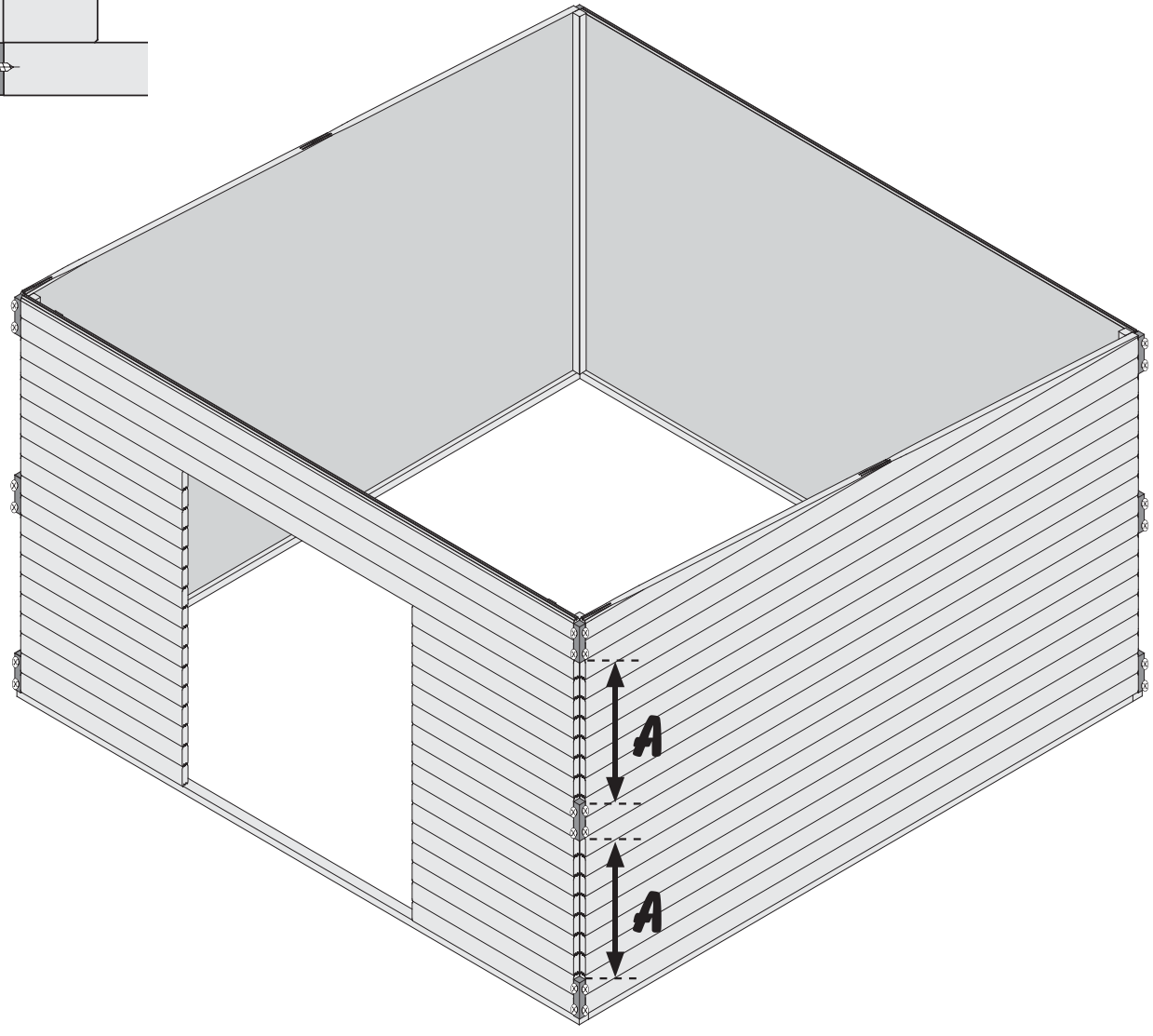
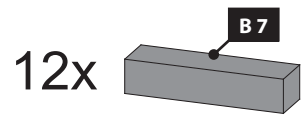
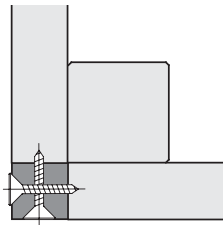
08.1-2







 Lieber Kunde, achten Sie auf die richtige Aufbau-Variante!

 Dear customer, pay attention to the correct design variant!

 Cher client, attention à la version de montage correct!

 Geachte klant, let dan op de juiste montage-versie!





 Geachte klant, let dan op de juiste montage-versie!

 Estimado cliente, prestar atención a la versión montaje correcto!

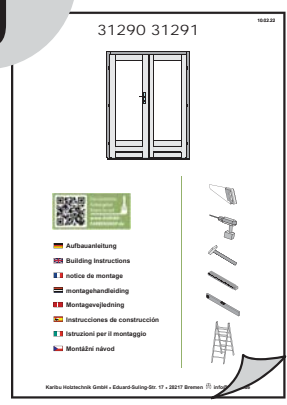
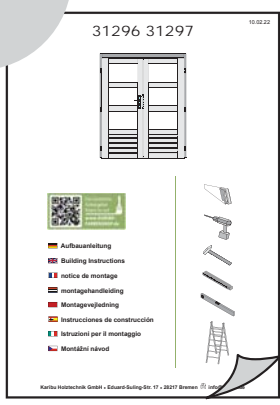
 Caro cliente, prestare attenzione alla versione corretto montaggio!

 Vážený zákazník, dbát na správnou montážní verzi!



-  Bündig!
-  Flush!
-  Affleurement!
-  Gelijk!
-  I flugt!
-  Aras!
-  Combacia!
-  Stejný !

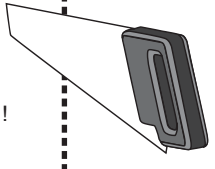

01

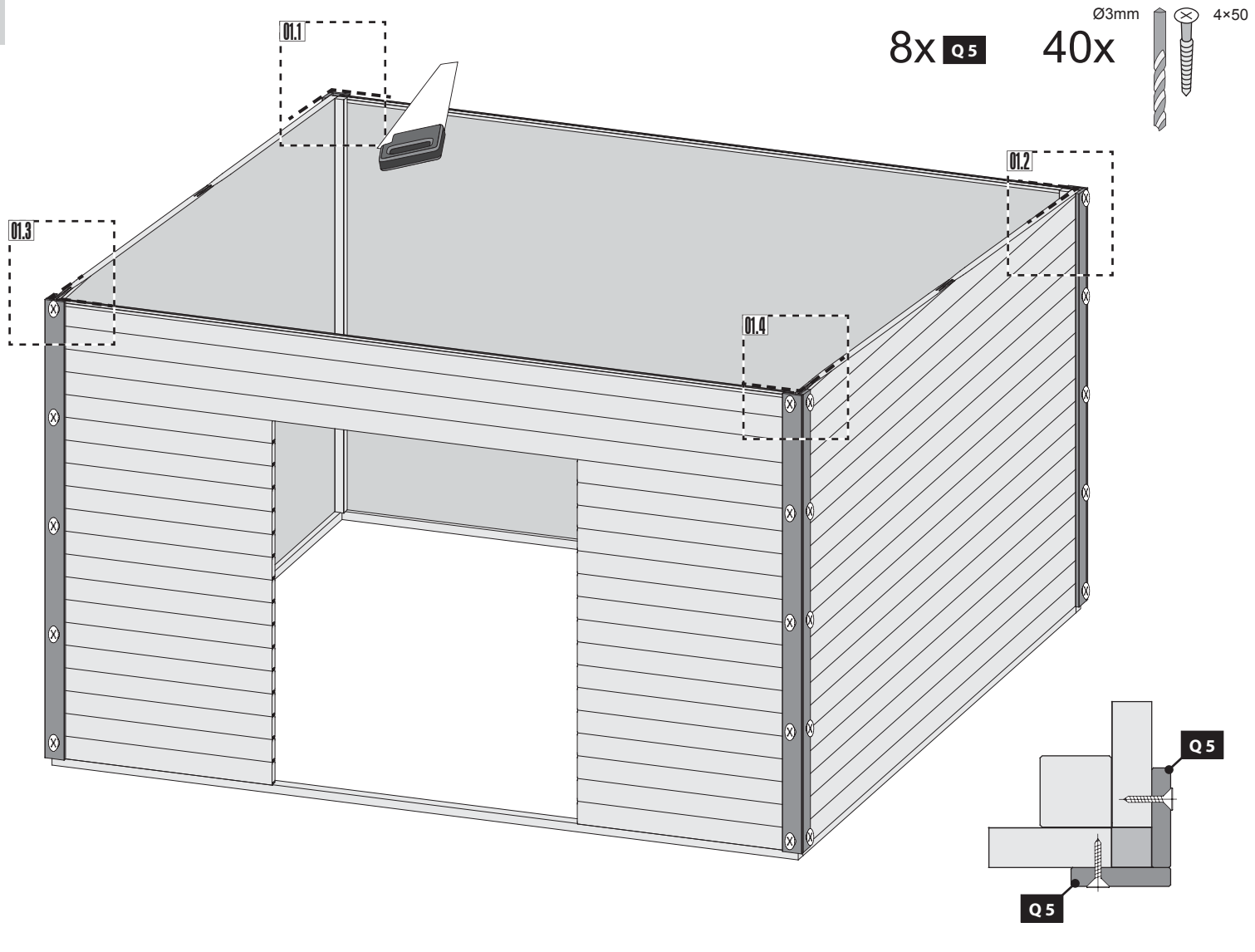

01.1

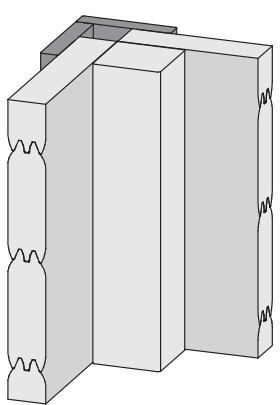

01.2

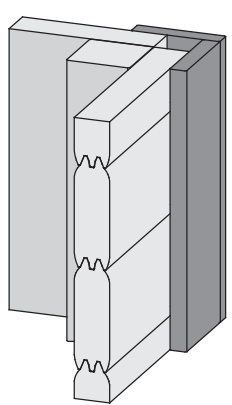

01.3

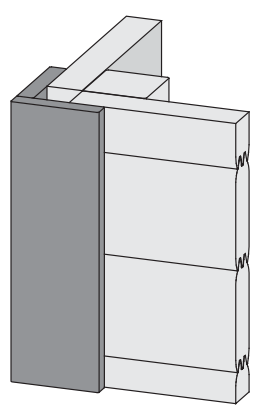

01.4

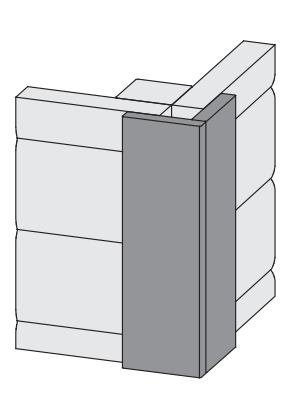

-  Bündig!
-  Flush!
-  Affleurement!
-  Gelijk!
-  I flugt!
-  Aras!
-  Combacia!
-  Stejný!

B



01

4x **C2** Silikon *
Silicone
Silicón

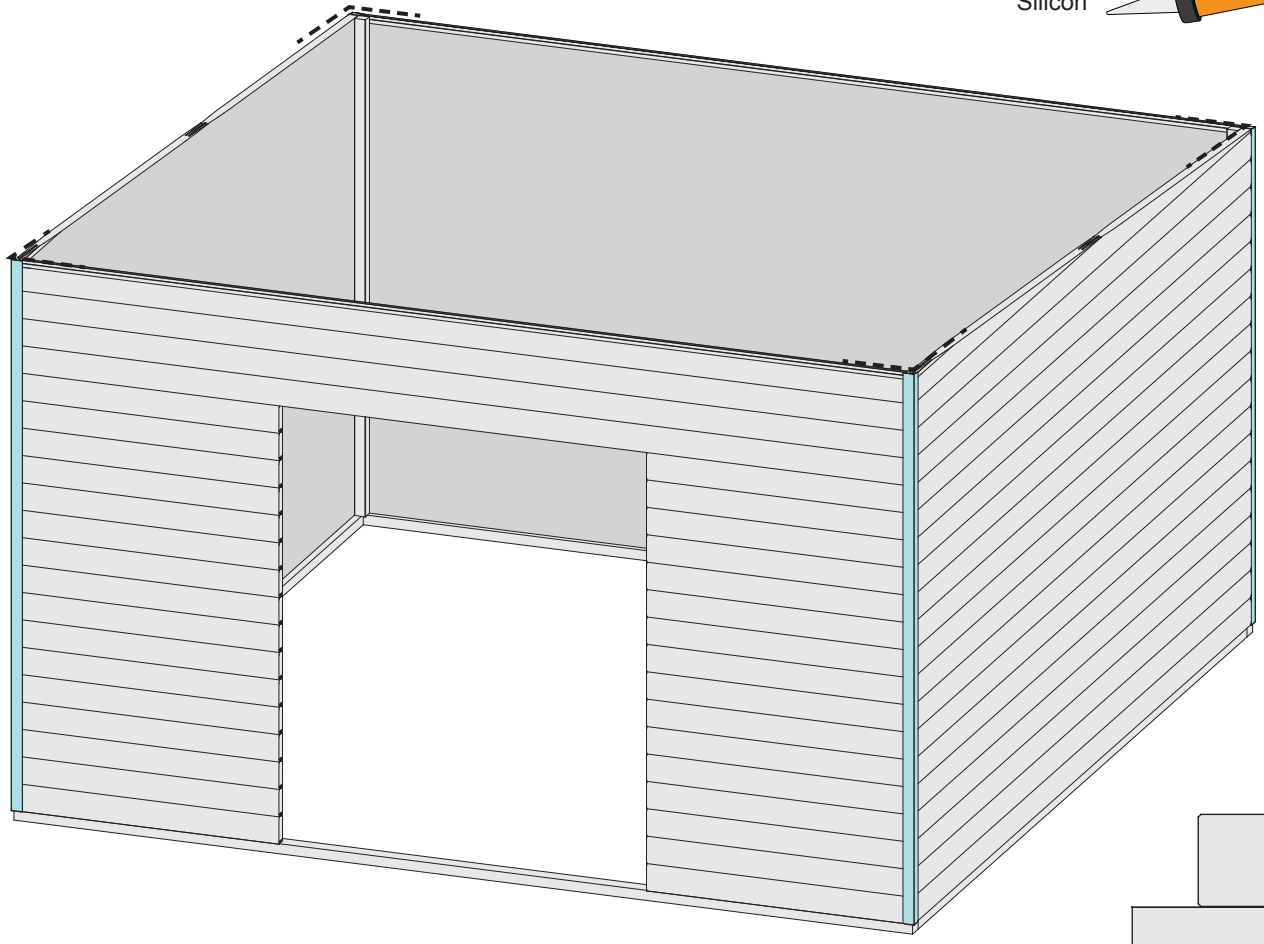
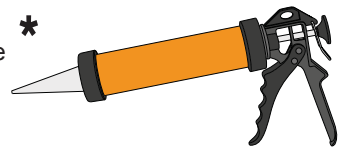



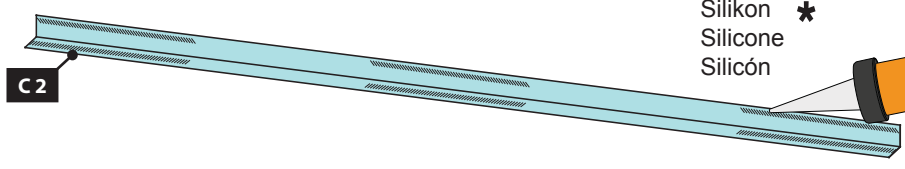

01.1 4x

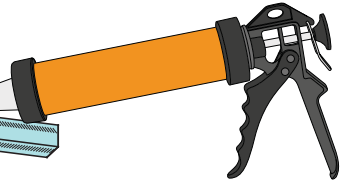

Silikon *
Silicone
Silicón



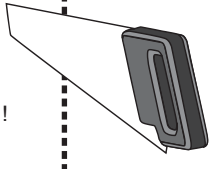

-  Bündig!
-  Flush!
-  Affleurement!
-  Gelijk!
-  I flugt!
-  Aras!
-  Combacia!
-  Stejný !

B



02

8x **Q2** 40x  Ø3mm  4x50

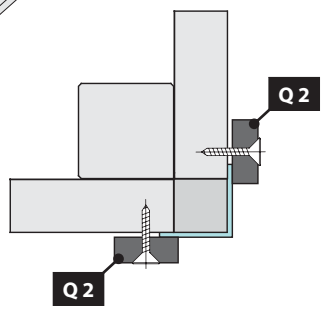
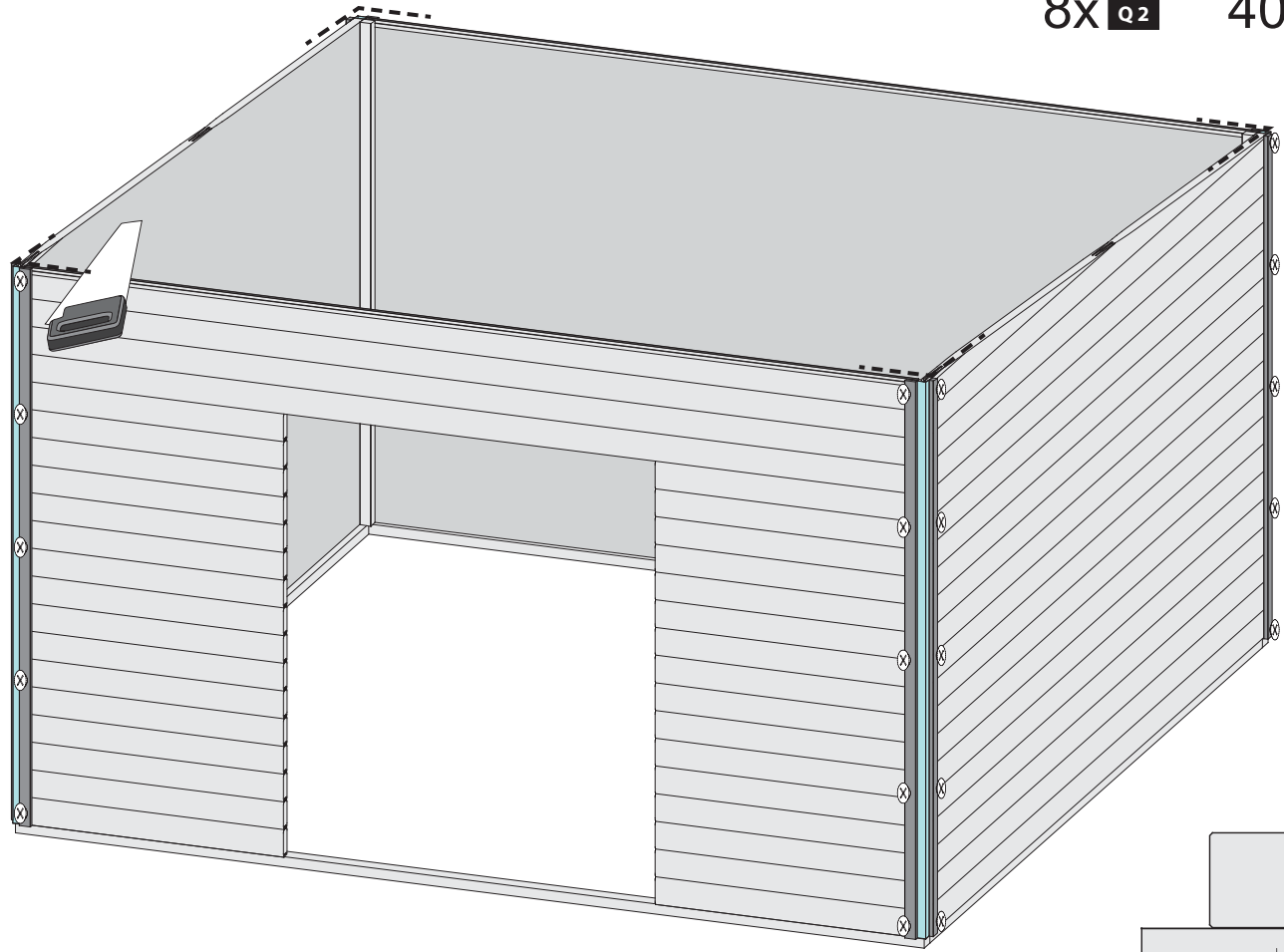

02.1

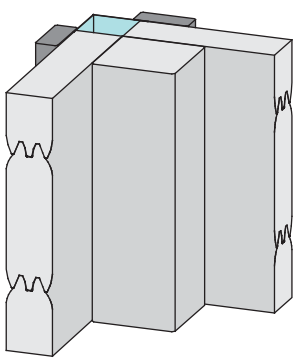

02.2

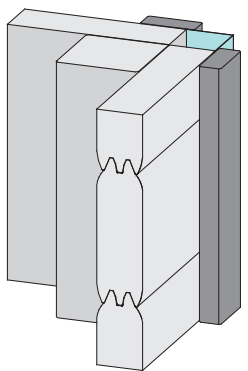

02.3

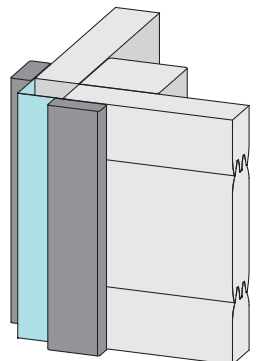

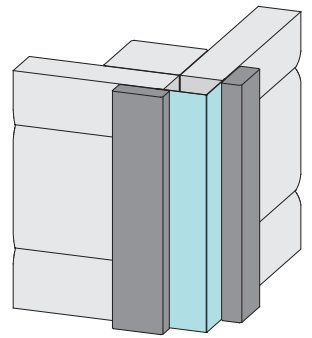

02.4



 Lieber Kunde, achten Sie auf die richtige Aufbau-Variante!

 Dear customer, pay attention to the correct design variant!

 Cher client, attention à la version de montage correct!

 Geachte klant, let dan op de juiste montage-versie!

 Geachte klant, let dan op de juiste montage-versie!

 Estimado cliente, prestar atención a la versión montaje correcto!

 Caro cliente, prestare attenzione alla versione corretto montaggio!

 Vážený zákazník, dbát na správnou montážní verzi!

10 A 12x

Ø3mm 4x70
72x

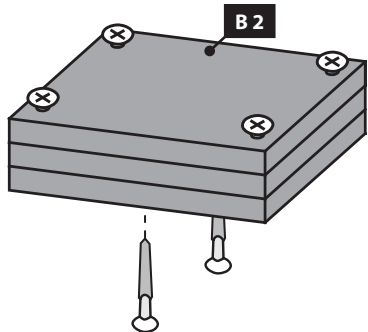

10 B / C 6x

Ø3mm 4x70
36x

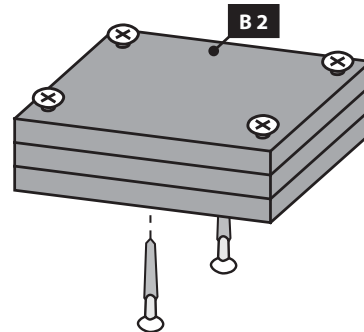

11

-  Draufsicht
-  Top view
-  vue de dessus
-  bovenaanzicht
-  vista desde arriba
-  vista desde arriba
-  vista dall'alto
-  půdorys

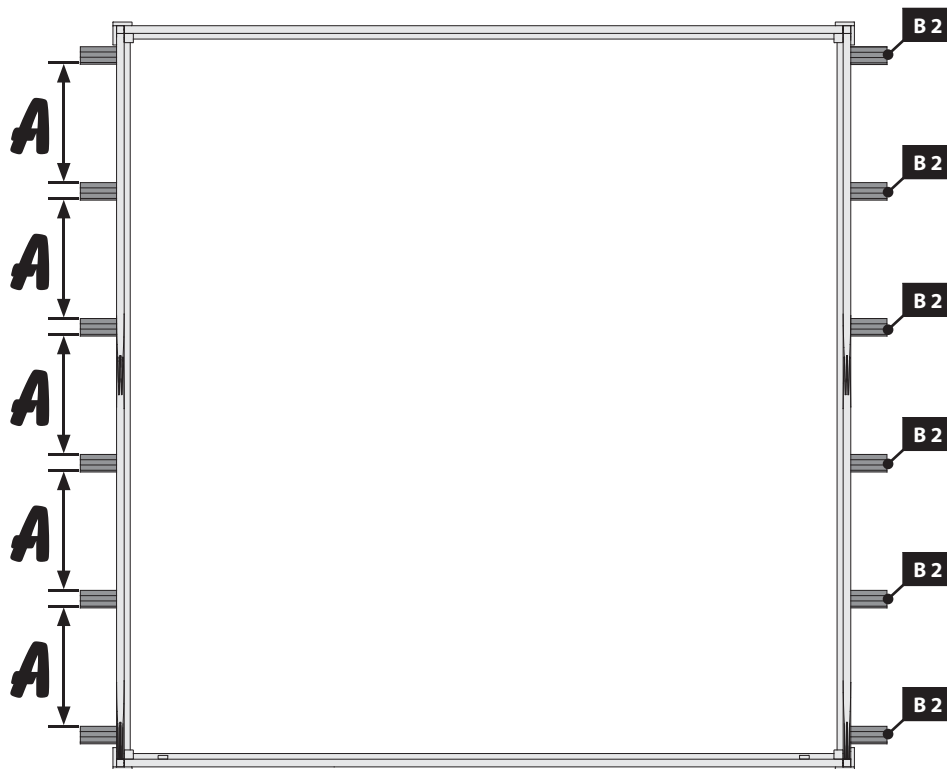

-  Seitenwand
-  Side wall
-  paroi latérale
-  zijwand
-  sidevæg
-  pared lateral
-  parete laterale
-  boční stěna

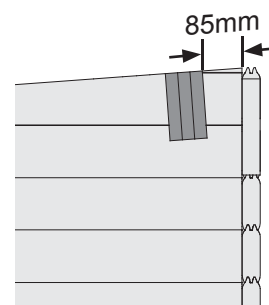
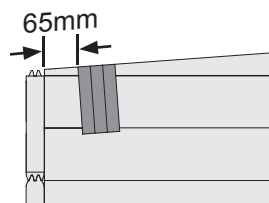

11A

Ø3mm 4,5×80

36x

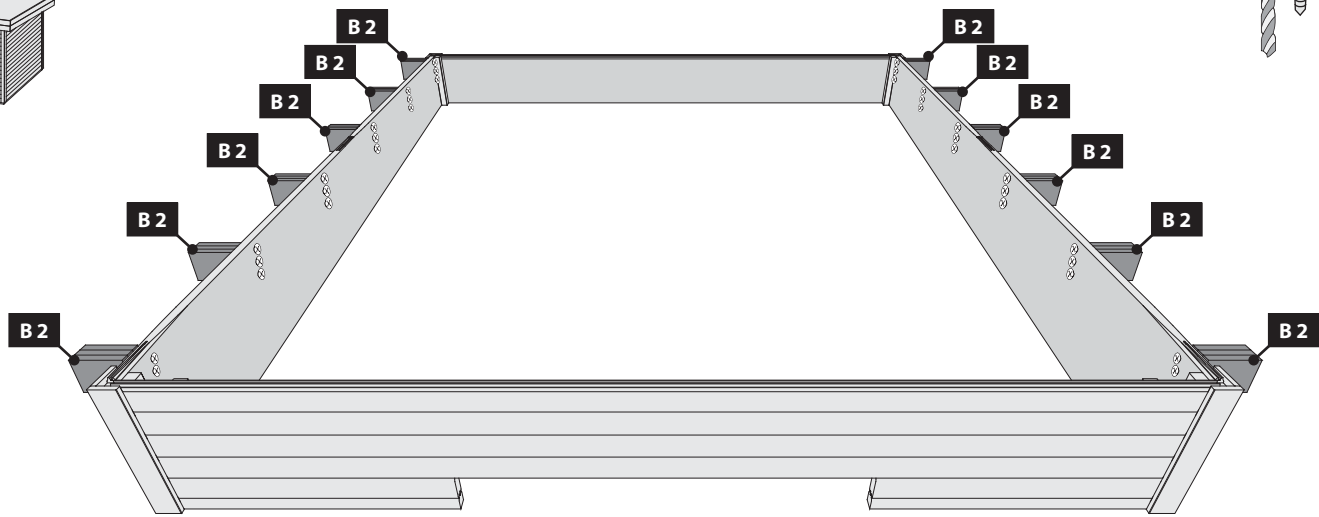
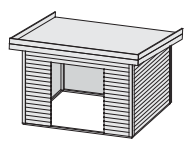

11B

Ø3mm 4,5×80

18x

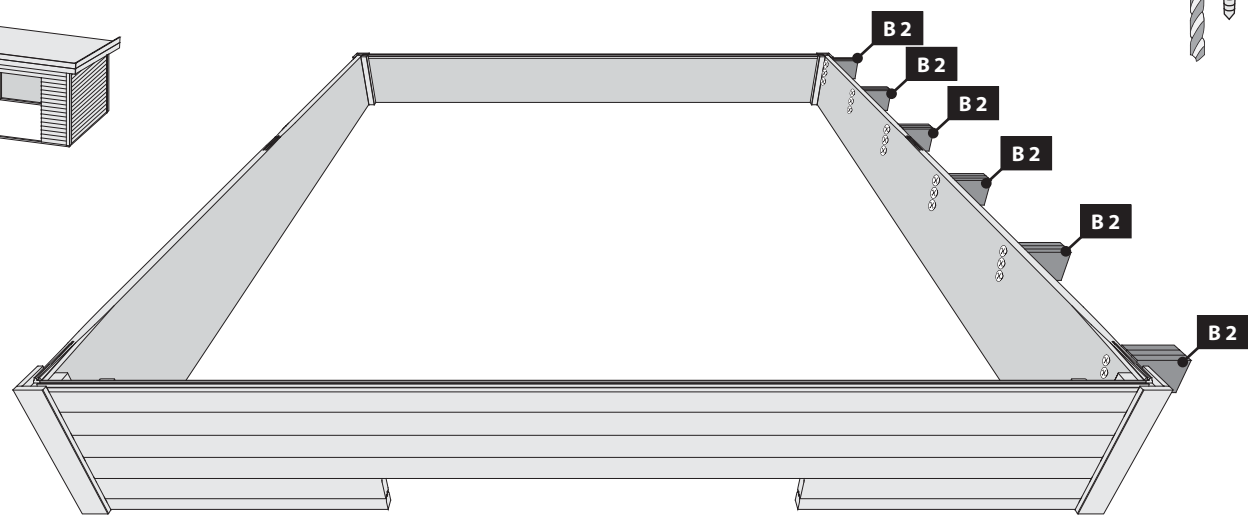
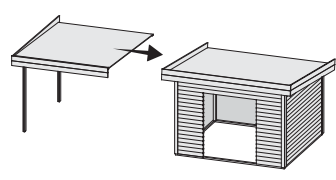

11C

Ø3mm 4,5×80

18x

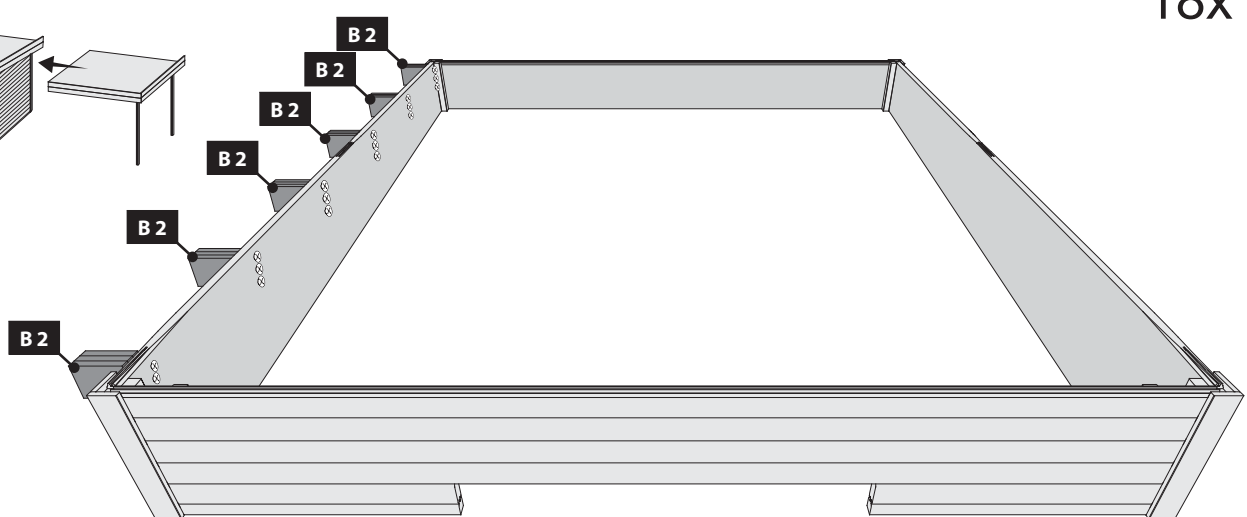
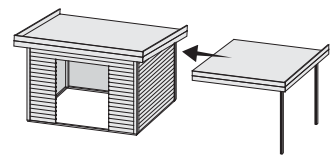

12 3x

Ø3mm 4x50

72x

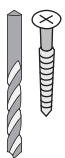
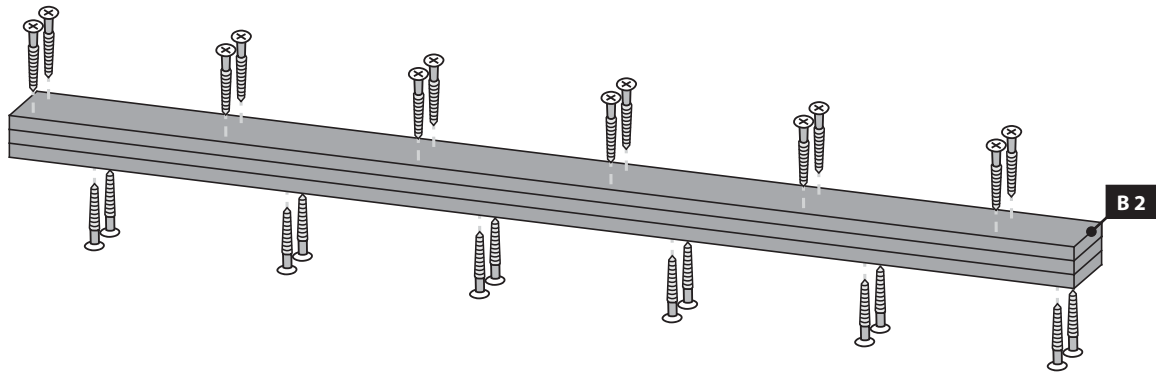

13

Ø3mm 4x35

56x

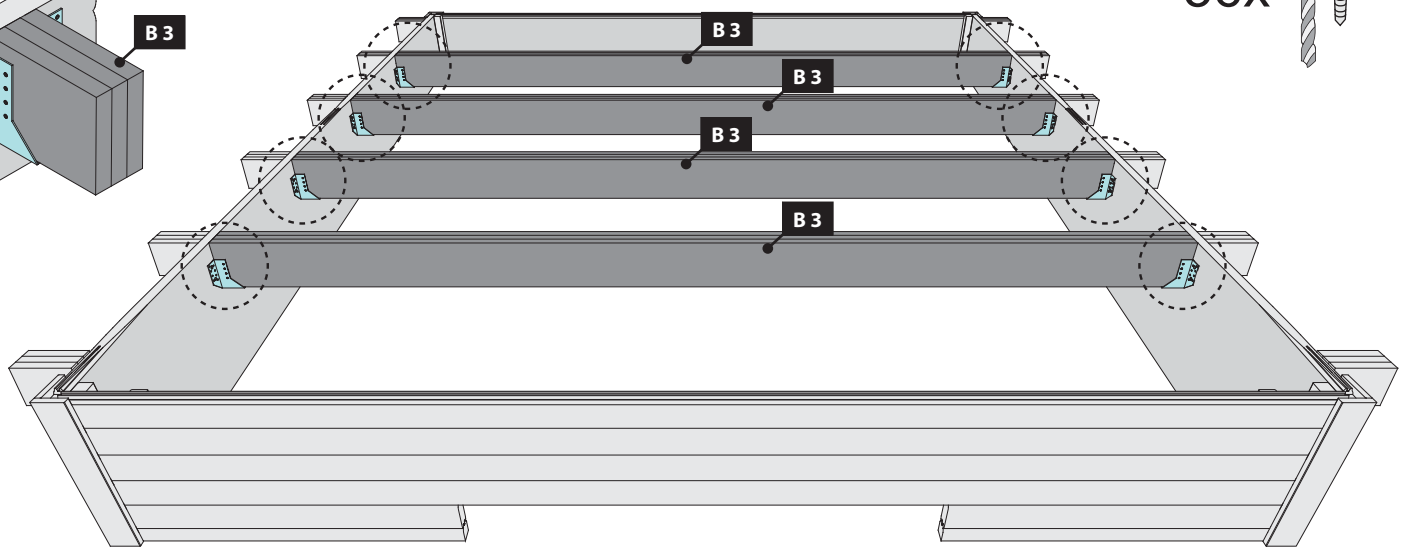
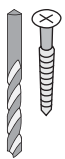
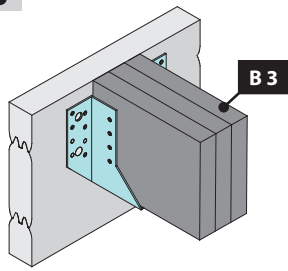

-  Bündig!
-  Flush!
-  Affleurement!
-  Gelijk!
-  I flugt!
-  Aras!
-  Combacia!
-  Stejný !

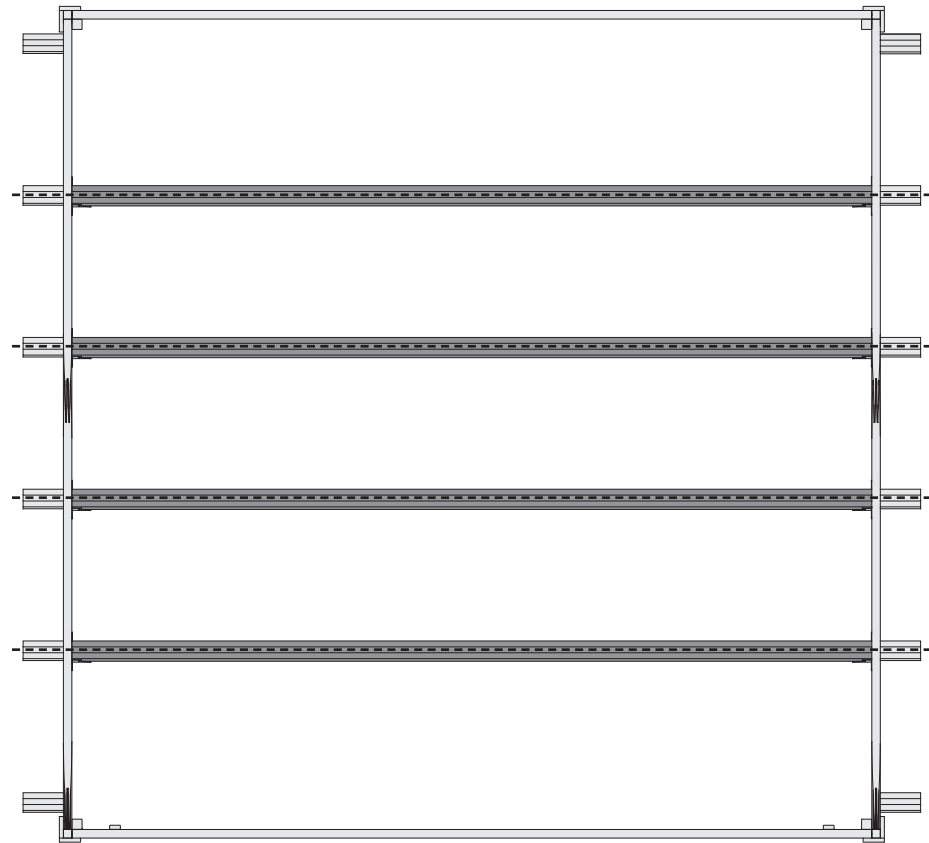

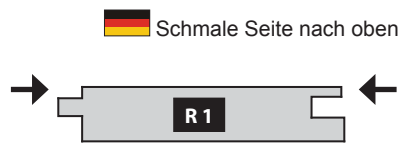
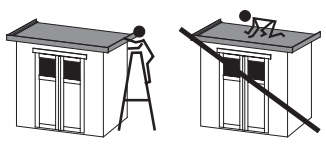

Schmale Seite nach oben

Narrow side up

Estrecha hacia arriba

Narrow vers le haut

Stretta verso l'alto

Smalle kant naar boven

Úzká stranou nahoru

- Bündig!
- Flush!
- Affleurement!
- Gelijk!
- I flugt!
- Aras!
- Combacia!
- Stejný!

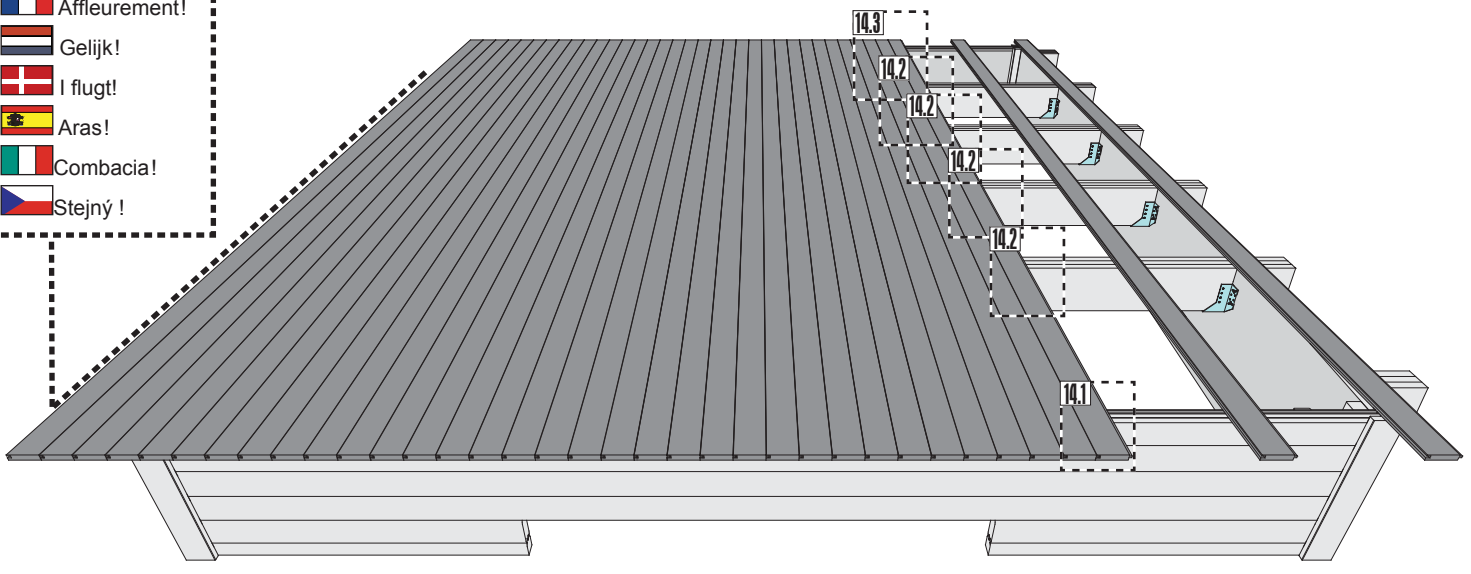

14.1

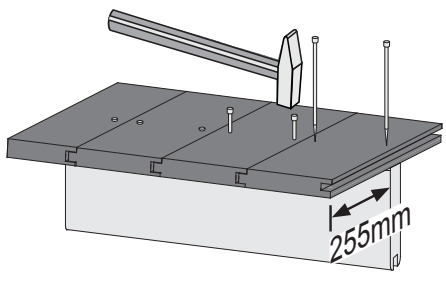

14.2

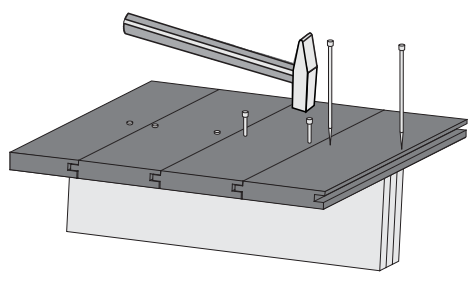

14.3

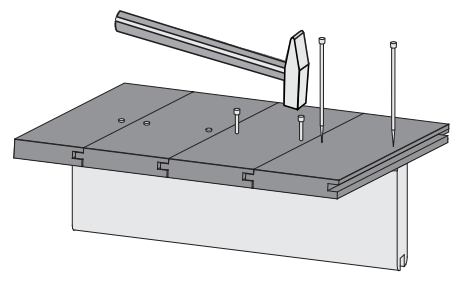

15

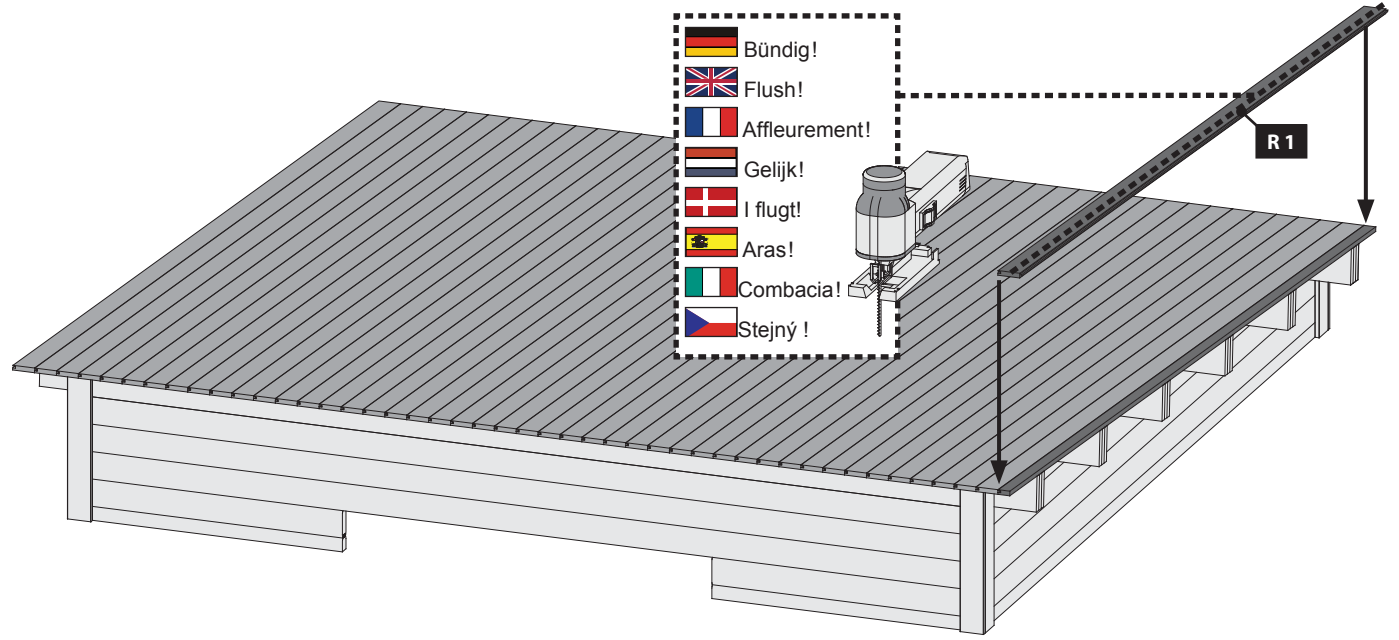

- Bündig!
- Flush!
- Affleurement!
- Gelijk!
- I flugt!
- Aras!
- Combacia!
- Stejný!

16 1x

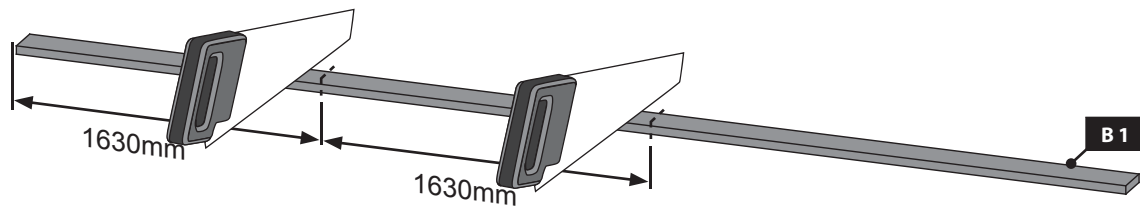
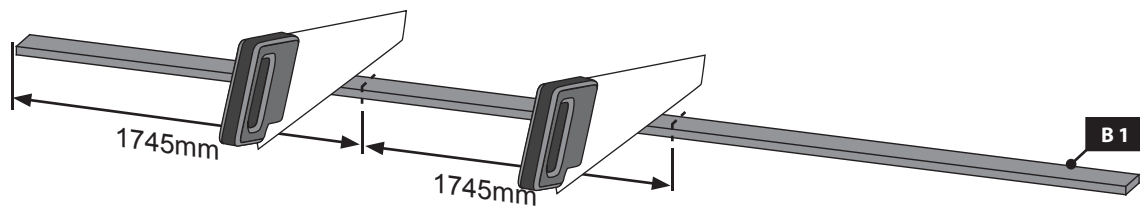

17

Ø3mm 4x30
12x

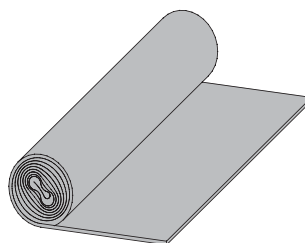
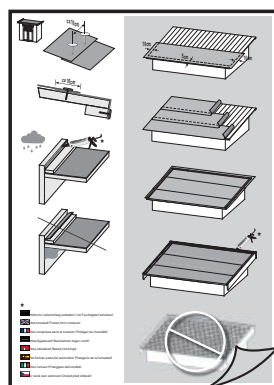
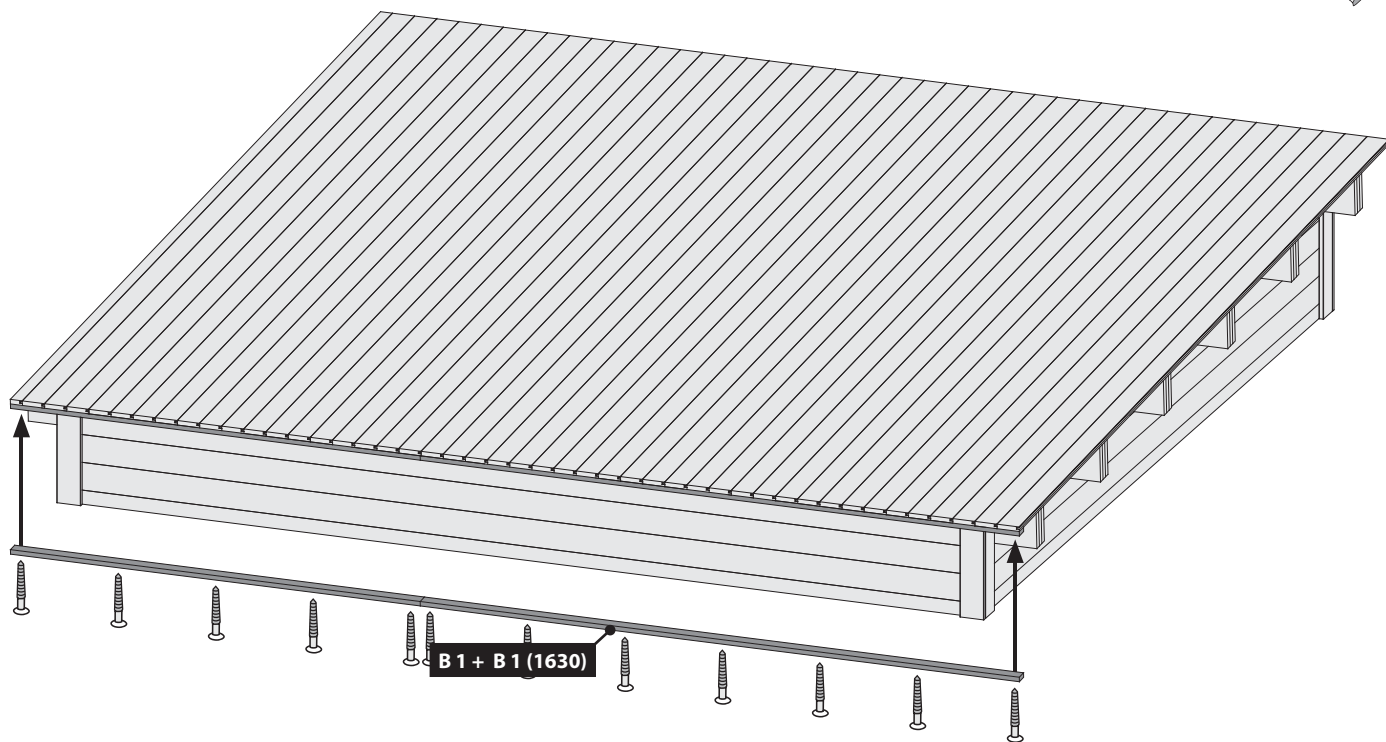

- *
- Nicht im Lieferumfang enthalten
 - Not included
 - Non comprises dans la livraison
 - Niet bijgeleverd
 - No forman parte del suministro
 - Non incluso
 - V ceně není zahrnuto
 - Ikke inkluderet

 Montage Bitumendachbelag

 Montage de toiture en bitume

 Montage bitumen underpap

 Copertura bituminosa

 Roofing felt installation

 Montage dakvilt

 Montaje de tela asfáltica

 montáž střešní krytiny

Achtung, dies ist nur ein Verlegebeispiel!

Die Anzahl der Bahnen richtet sich nach Ihrer Hausgröße. Verbindungen zwischen den Bahnen sind mit einer Überlappung von ca. 10 cm auszuführen. Das Dach ist nicht begehbar. Die Konstruktion ist für eine Gesamtbelastung (Schnee, Wind) und nicht für eine Punktbelastung ausgelegt. Zur Montage empfehlen wir eine bauseitige Abstützung des Daches von unten. Die Abdichtung der Dachflächen zu angrenzenden Bauteilen mit Bitumendichtmasse ist bauseits zu lösen! Sofern es sich um ein Haus mit Satteldach handelt, sollte bei der Verwendung von Dachschindeln keine Voreindeckung mit Dachpappe vorgenommen werden. Hier sollte lediglich an den beiden Traufseiten ein 20 cm breiter Streifen mit Überstand angebracht werden. Bei Häusern mit einem Tonnendach, verlegen Sie bitte einen Bitumenbelag unter die Schindeln. Bei einem Flachdach ist die Verlegung von Dachschindeln nicht möglich!

Note! This description is only an example!

The number of bitumen strips to be used depends on your actual house size. When joining rolls of roofing felt end to end, the overlap must be approximately 10cm. The roof is not safe to walk on. The roof is designed for a total load (snow, wind) and not for a point load. We recommend you to always support the roof from below during installation. The sealing of the roof surfaces to adjacent components with bitumen sealant has to be effected by the customer! If it is a saddle-roofed house, do not use roofing tiles for roofing. In this case, a 20 cm wide strip of bitumen with overhang should be installed on both sides of the eaves. For houses with a tonne roof, please install a bitumen roofing under the shingles. In the case of a flat roof the laying of roof shingles is not possible!

Attention, il s'agit uniquement d'un exemple de pose!

Le nombre de bandes de bitume utilisés dépend de la dimension de la maison. La jointure des bandes de bitume doit être réalisée avec un chevauchement de 10 cm. Ne pas marcher sur le toit! La construction est appropriée pour une charge totale (neige, vent) et ne pas une charge ponctuelle sur un point précis. Lors du montage, il vous est recommandé de soutenir le toit d'en dessous. L'imperméabilisation des surfaces de toit aux composants adjacents avec un mastic de bitume doit être effectuée par le client! Lorsque vous utilisez des bardeaux pour couvrir une maison avec un toit à deux versants, ne jamais utiliser toiture en bitume ci-dessous. Pour les maisons avec toit en berceau, poser du carton bitumé sous les bardeaux. Pour les maisons de toit plat de la pose de bardeaux de toiture n'est pas possible!

Let op, dit is slechts een montagevoorbeeld!

Het aantal dakviltbanen is afhankelijk van de grootte van uw huis. Verbindingen tussen de stroken uit te voeren met een overlapping van ongeveer 10 cm. Het dak is niet beloopbaar. De constructie is ontworpen voor een totaalbelasting (sneeuw, wind) en niet voor een puntbelasting. Voor de montage adviseren we te voorzien in een zelf aan te brengen steun voor het dak van onderen. De afdichting van de dakoppervlakken van aangrenzende componenten met bitumen afdichtmiddel op te lossen door de klant! Als het gaat om huis met een zadeldak, mag geen Voreindeckung worden gemaakt met dakleer in het gebruik van dakbedekking gordelroos. Hier, moet alleen de twee dakrand zijden een 20cm brede strook dakleer aan te leggen met een overstek. Voor huizen met een dak vat installeer dan een dakleer onder de gordelroos. Met een plat dak leggen shingles is niet mogelijk!

Bemærk, dette er kun et monteringseksempel!

Antallet af påkrævede ruller af tagbeklædning afhænger af husets faktiske størrelse. Ved sammenføjning af tagdækning ruller ende til ende, skal overlappningen være 10 cm. Når du kun bruger 4 baner af tagpap, skal du altid dække den vandrette kantbjælke med rullerne fra begge sider. Taget er ikke sikkert at gå på. Taget er designet til en total belastning (sne, vind) og ikke for en punktblastning. Vi anbefaler at du altid støtter taget nedenunder under installationen. Tætningen af tagfladerne til vindbrættet i forenderne skal løses af kunden! Når du bruger tagshingles til at inddække et hus med gavtag, skal du altid bruge underpap tagbeklædningen. Her lægges et 20 cm bredt bånd af tagbeklædning med overlæg på begge sider. Monter altid underpap tagbeklædningen under tagshingles til huse med et buet tag. Ved fladt tag kan tagshingles ikke anvendes!

Cuidado, éste es sólo un ejemplo de instalación!

La cantidad de tiras de tela asfáltica depende del tamaño de su caseta. Las juntas de tela en una tira se realizan solapando la tela asfáltica 10 cm. El techo no es transitable. La construcción está preparada para cargas totales (nieve, viento) y no para cargas puntuales. Para el montaje se recomienda apuntalar el techo por debajo. A menos que haya una casa de techo a dos aguas, sin Voreindeckung debe hacerse con tela asfáltica en el uso de tejas para techos. En este caso, sólo los dos aleros partes deben ser de una amplia franja de 20 cm de tela asfáltica que deben colocarse con un voladizo. Para las casas con el techo abovedado y por favor, instale un techo sintió debajo de las tejas. Con un techo plano por el que las tejas no es posible!

Attenzione, questo è solo un esempio di posa!

La quantità dei rulli di cartone catramato dipende dalle dimensioni della casa. Il concatenamento tra i nastri deve essere effettuata con una sovrapposizione di circa 10 cm. Non salire sul tetto. La costruzione è progettata per un carico diffuso (neve, vento) e non per una concentrazione puntuale del peso. Per il montaggio si consiglia un supporto del tetto con una costruzione posta sotto di esso. Se si dispone di una casa con un tetto a capanna e si desidera utilizzare tegole di copertura, deve essere posato senza fogli di bitume. Qui, un largo 20 cm striscia di bitume deve essere montato esclusivamente ad entrambi i lati della grondaia sporgente 20 cm. Per le case con fogli di bitume per tetti a botte sotto il fuoco di Sant'Antonio da installare. Si prega di non utilizzare il fuoco di Sant'Antonio Dackdeckung con un tetto piatto.

Pozor, toto je jen příklad, kterým!

Počet Dachpappbahnen závisí na velikosti domu. Spojení mezi asfaltem pásu má být provedena s přesahem asi 10 cm. Při použití pouze čtyři běhy ne Firstbahn použití, boční panely s ležel přes hřeben. Střecha není přístupný. Konstrukce je (sníh, vítr) a není určen pro bodové zatížení na celkové zatížení. Pro montáž doporučujeme znovu podporu na místě střechy zespodu. Utěsnění střešních oblastí do podhledu na čelních plochách je na místě řešit! Máte-li dům se sedlovou střechou, je třeba žádné Asfaltové pásy umístěny pod šindele. Zde je 20 cm široký pás střešní plst' je pouze na obou stranách okapového se supernatantem odloženou. Pro rodinné domy s valenou střechou prosím ležel lepenkový pod šindelem. Pro ploché střechy domů pokládka střešních šindelů není možné!

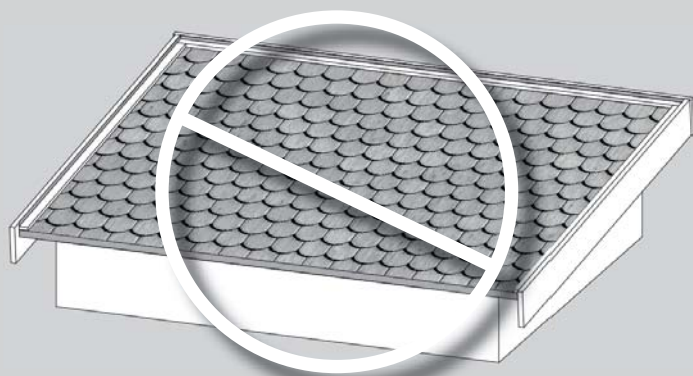
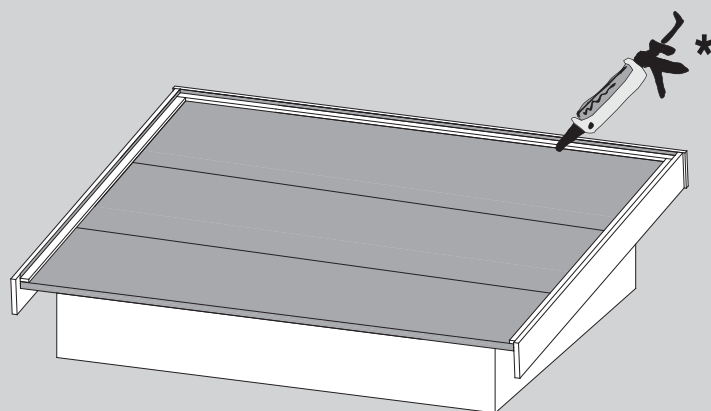
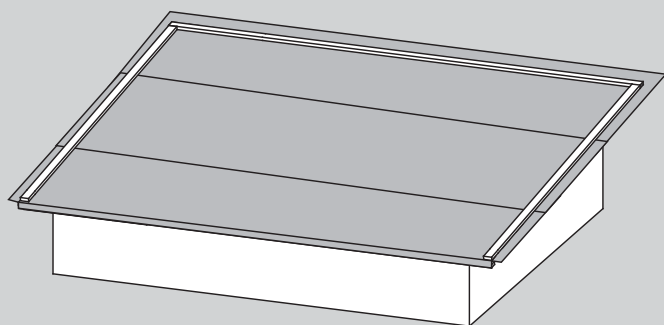
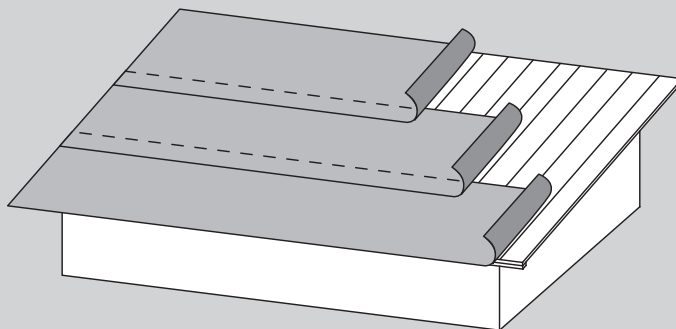
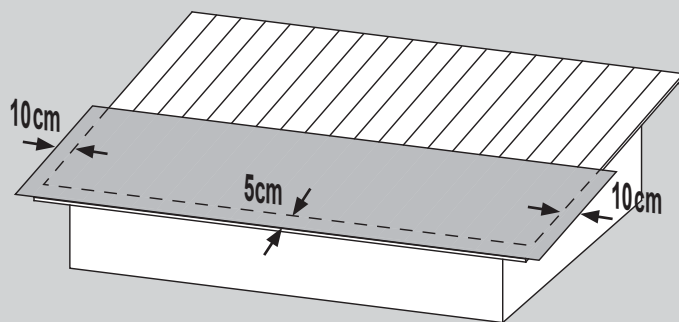
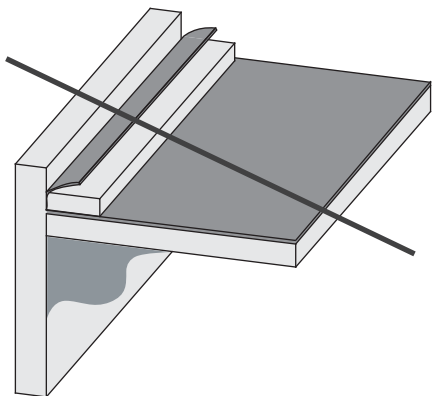
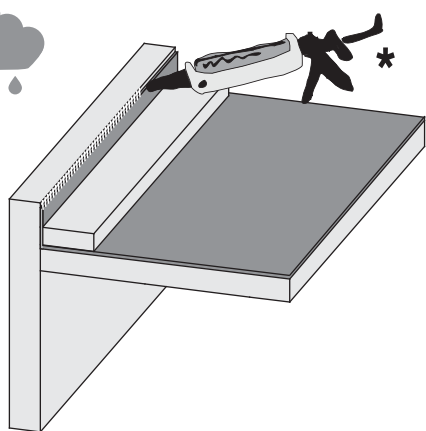
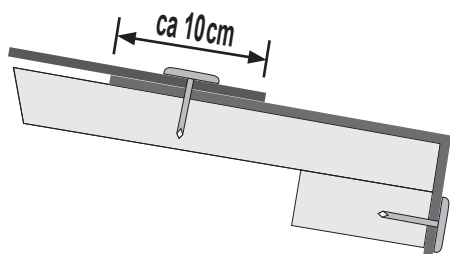
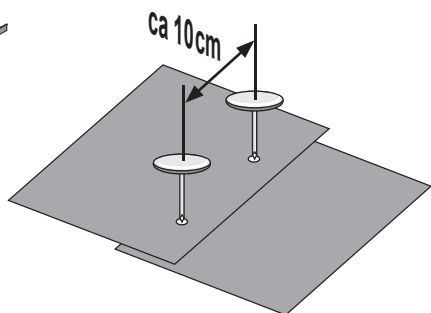
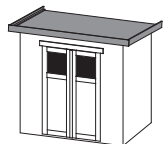



*

 Nicht im Lieferumfang enthalten! Vor Feuchtigkeit schützen!

 Not included! Protect from moisture!

 Non comprises dans la livraison! Protéger de l'humidité!

 Niet bijgeleverd! Beschermen tegen vocht!

 Ikke inkluderet! Beskyt imod fugt!

 No forman parte del suministro! Protegerlo de la humedad!

 Non incluso! Proteggere dall'umidità!

 V ceně není zahrnuto! Chránit před vlhkostí!

18

Ø3mm 4x30

33x

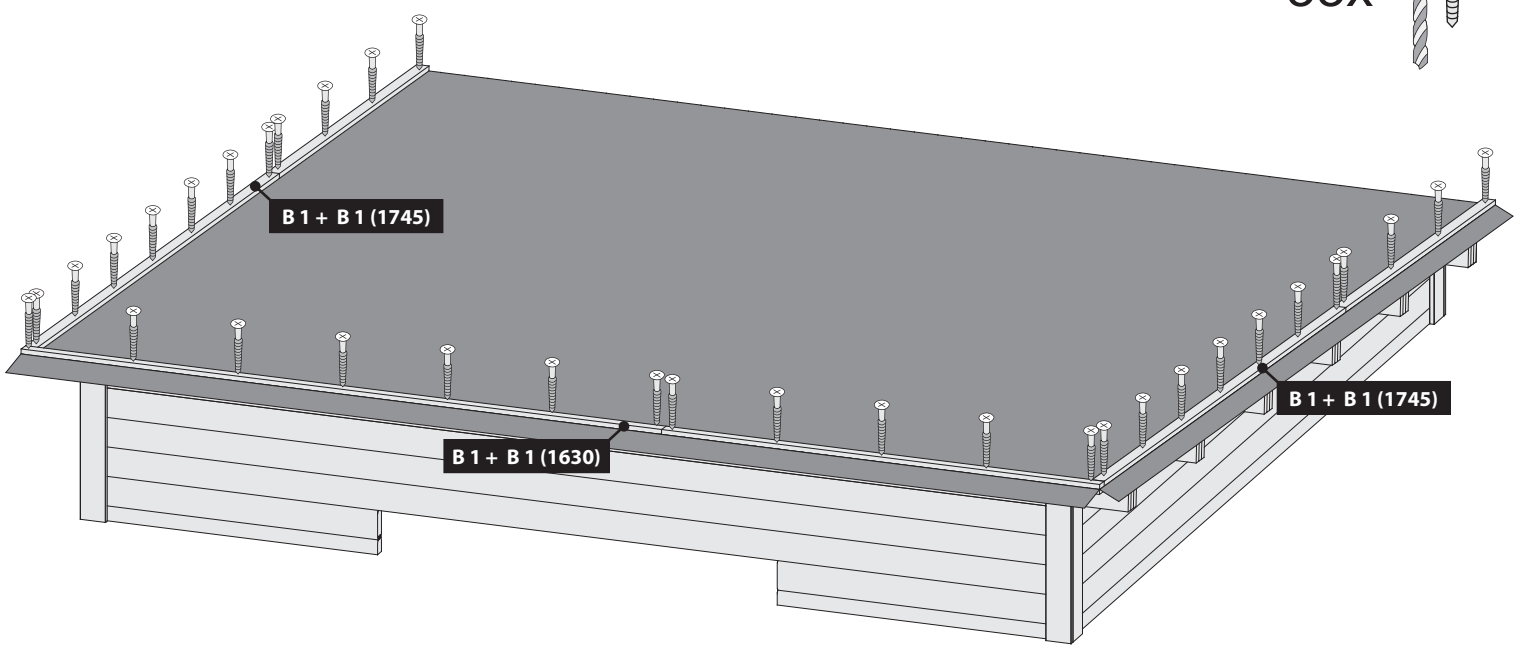
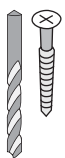

19

2x

Ø3mm 4x35

16x

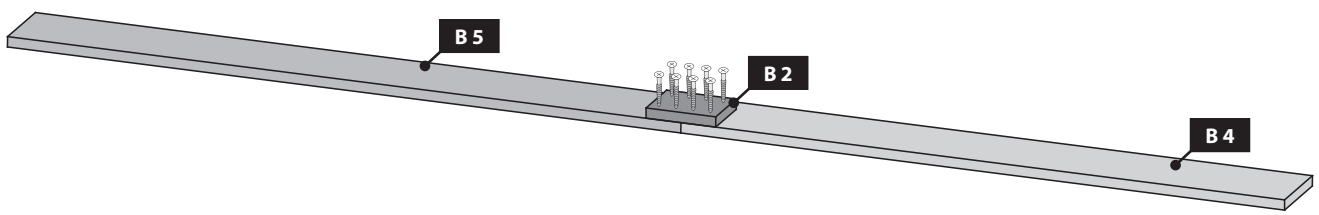
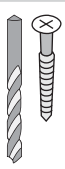

20

Ø3mm 4x50

16x

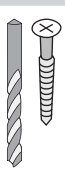

-  Bündig!
-  Flush!
-  Affleurement!
-  Gelijk!
-  I flugt!
-  Aras!
-  Combacia!
-  Stejný !

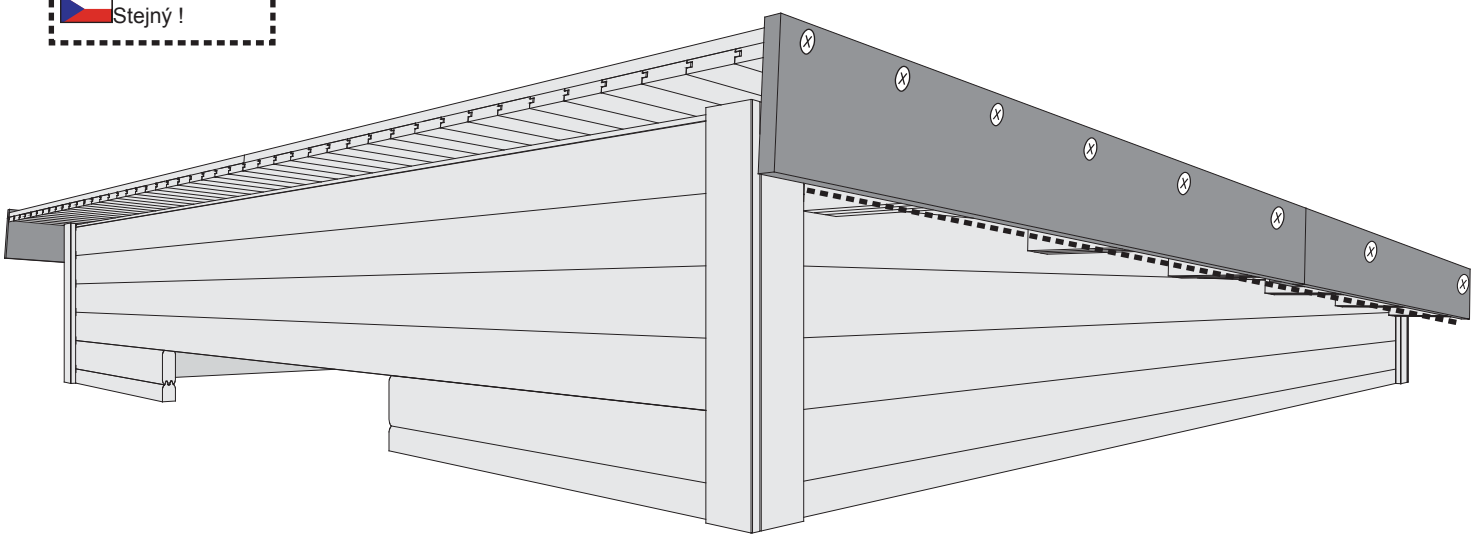

21

Ø3mm 4x35

8x

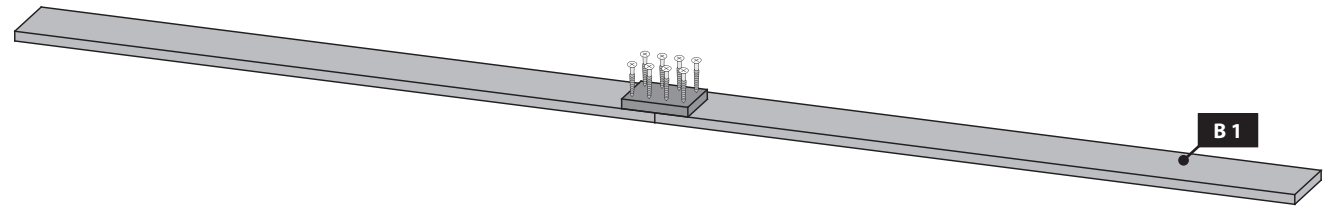
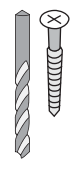

22

Ø3mm 4x50

12x

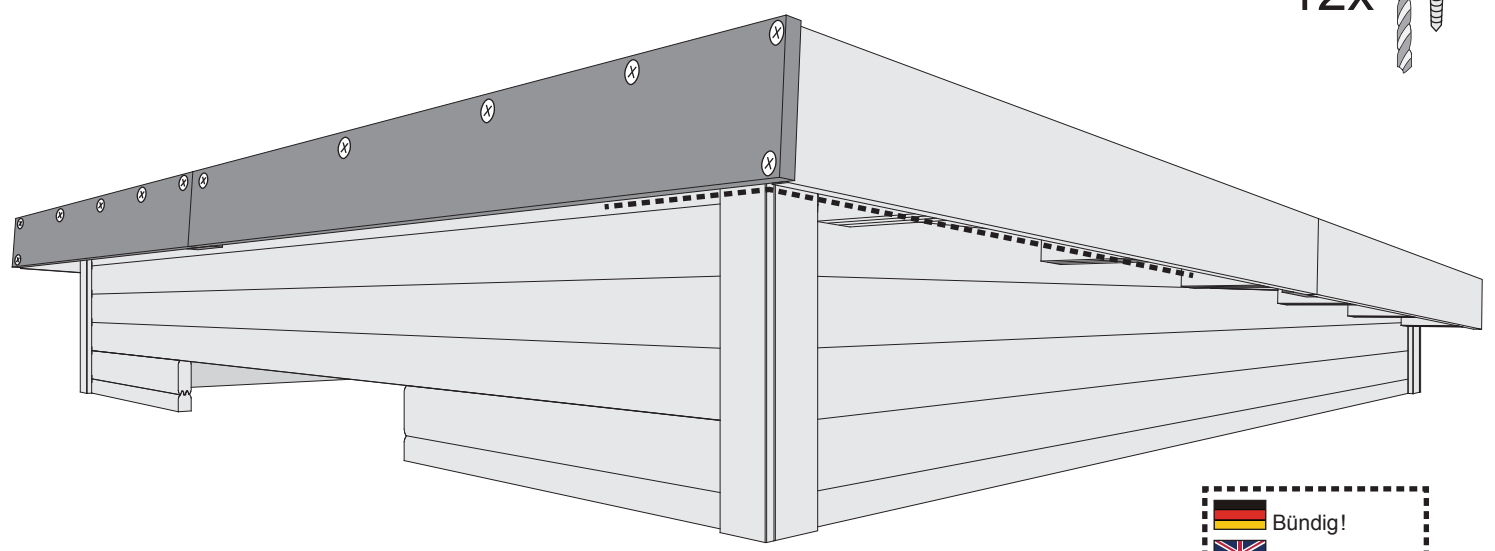
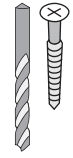

-  Bündig!
-  Flush!
-  Affleurement!
-  Gelijk!
-  I flugt!
-  Aras!
-  Combacia!
-  Stejný!

23



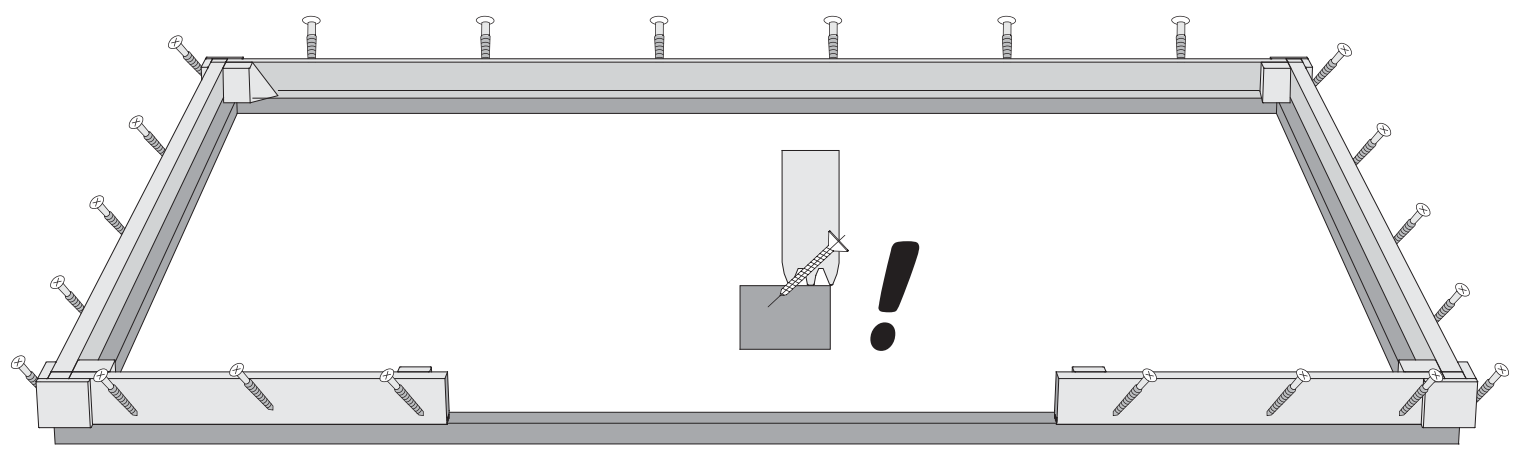
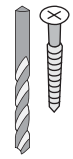

Ø3mm 4x50

22x

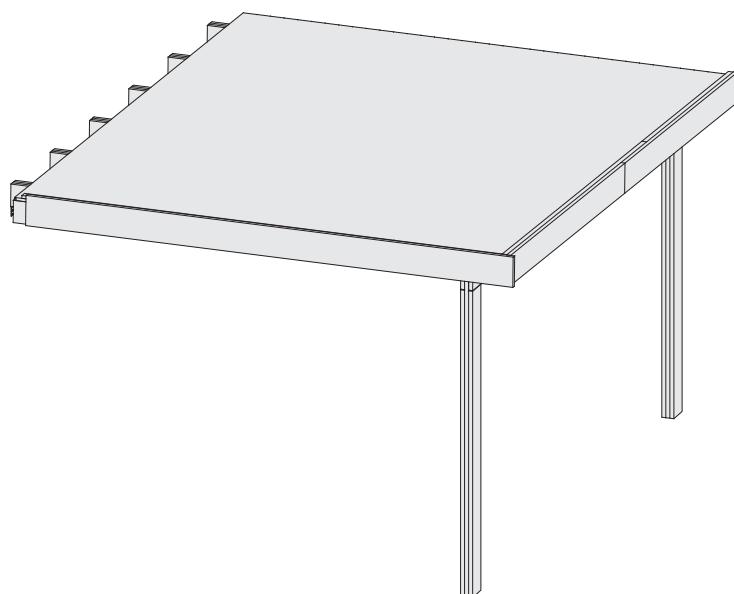

31308 31309





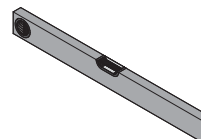
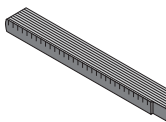
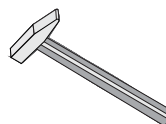
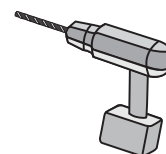
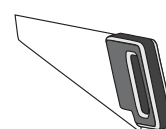

-  **Aufbauanleitung**
-  **Building Instructions**
-  **notice de montage**
-  **montagehandleiding**
-  **Montagevejledning**
-  **Instrucciones de construcción**
-  **Istruzioni per il montaggio**
-  **Montážní návod**











 Bitte bewahren Sie die Anleitung und den Garantieschein zur Seriennummer auf. Vernichten Sie diese erst nach Ablauf der Garantiezeit. Eventuelle Beanstandungen können mithilfe der Stückliste einfacher zugeordnet werden.





Beigelegte Dokumente:

- Informationsheft
- Garantieschein zur Seriennummer
- Typenschild inkl. Warnhinweise (Sauna)
- ggf. Zubehör-Anleitungen in externen Paketen

- *  Nicht im Lieferumfang enthalten
 Not included
 Non comprises dans la livraison
 Niet bijgeleverd



-  No forman parte del suministro
 Non incluso
 V ceně není zahrnuto
 Ikke inkluderet

- 1  Länge muss ermittelt und zugesägt werden
 Length must be determined and sawn
 La longueur doit être déterminée et sciée
 De lengte moet worden bepaald en worden gezaagd

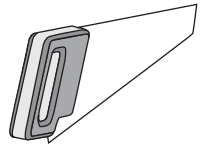
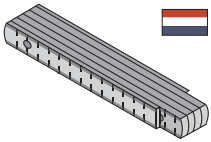
-  La longitud debe ser determinada y aserrada
 La lunghezza deve essere determinata e segata
 Délka musí být určena a rozřezána
 Længden skal bestemmes og saves



- 2  Nicht gebraucht
 Not needed
 Pas nécessaire
 Niet nodig



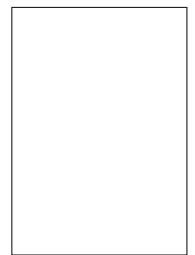

-  No es necesario
 Non necessario
 Není nutná

- 3  mit Zubehör!
 met toebehoren!
 with accessories!
 avec accessoires!



-  con accesorios!
 con accessori!
 s příslušenstvím!
 z dodatki!



- 4  Fixiert vorübergehend
 tijdelijk vast
 Fixed temporarily
 temporairement fixe

-  temporalmente fijo
 temporaneamente fisso
 dočasně pevný
 Zčasno pritrjeno

- 5  Bestand vom Haus
 Inventaris van het huis
 Inventory of the house
 Inventaire de la maison

-  Inventario de la casa
 Inventario della casa
 Inventář domu
 Inventar hiše

Werkzeuge / Tools*

X

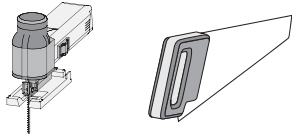

X

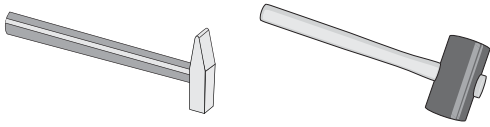

X

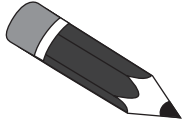

X

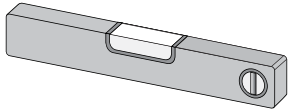

X

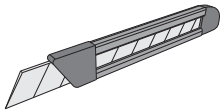

X

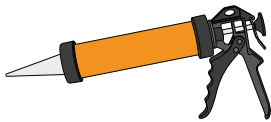
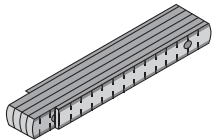

X

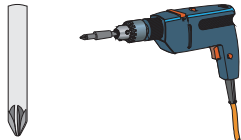

X

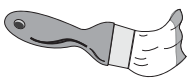
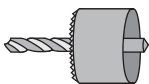
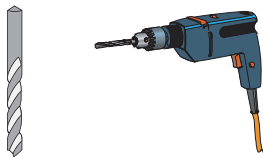

X





Vergleichen Sie zuerst die Material-liste mit Ihrem Paketinhalt! Bitte haben Sie Verständnis, dass Beanstandungen nur im nicht aufgebauten Zustand bearbeitet werden können!



Vergelijk eerst de lijst van materialen met de inhoud van uw pakket! Reclamaties kunnen alleen in behandeling worden genomen zolang de onderdelen nog niet zijn gemonteerd!



Confrontate questa distinta materiali prima con il contenuto del pacchetto! Vi preghiamo di comprendere che eventuali reclami possono essere accolti solo prima del montaggio!



First compare the list of materials with your package contents! Please understand that complaints can be processed in the non-built status only!



Start med at kontrollere materialelisten med indholdet af den leverede pakke! Vi gør venligst opmærksom på at reklamationer kun kan behandles for materialer som ikke er blevet bearbejdet!



Nejprve přezkontrolujte obsah balení podle materiálového listu! Mějte pochopení pro to, že případnou reklamaci se můžeme zabývat pouze tehdy, když díly nebudou smontované! Za pomoci tohoto seznamu můžete jednotlivé díly přiřadit k montážnímu návodu.



Commencez par comparer la liste du matériel avec le contenu de votre paquet! Sachez que nous traitons uniquement les réclamations concernant le matériel à l'état non monté!



En primer lugar, compare la lista de material con el contenido del paquete. Rogamos entienda que las reclamaciones sólo pueden ser tramitadas antes de montar el objeto!

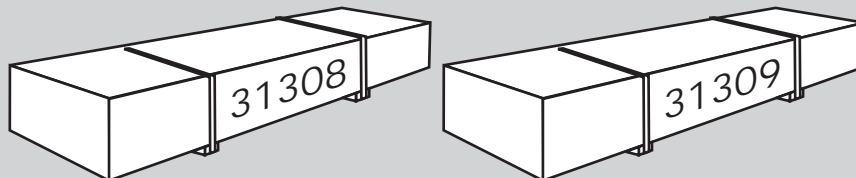

3 x F1	2100 x 45 x 18 mm	ID 19547
1 x F2	180 x 140 x 26 mm	ID 56910
4 x F3	1955 x 140 x 26 mm	ID 22178
2 x F4	2095 x 140 x 26 mm	ID 67732
1 x F5	3120 x 190 x 26 mm	ID 80539
1 x F6	3287 x 140 x 26 mm	ID 31303
18 x F7	3300 x 140 x 26 mm	ID 12351
2 x F8	3567 x 140 x 26 mm	ID 31302

12 x	ID 14041

30 x	4 x 30 mm	ID 3686
100 x	4 x 35 mm	ID 3687
10 x	4 x 50 mm	ID 3688
220 x	4 x 70 mm	ID 3689

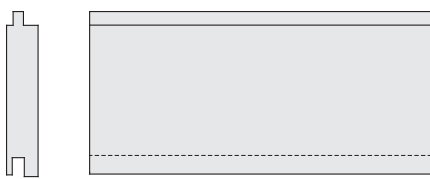

440 x	2,2 x 50 mm	ID 5621



36 x R1	3900 x 96 x 19 mm	ID 19573
---------	-------------------	----------

 Übersicht
 Overview
 enquête

 overzicht
 undersøgelse
 estudio

 sondaggio
 přehled

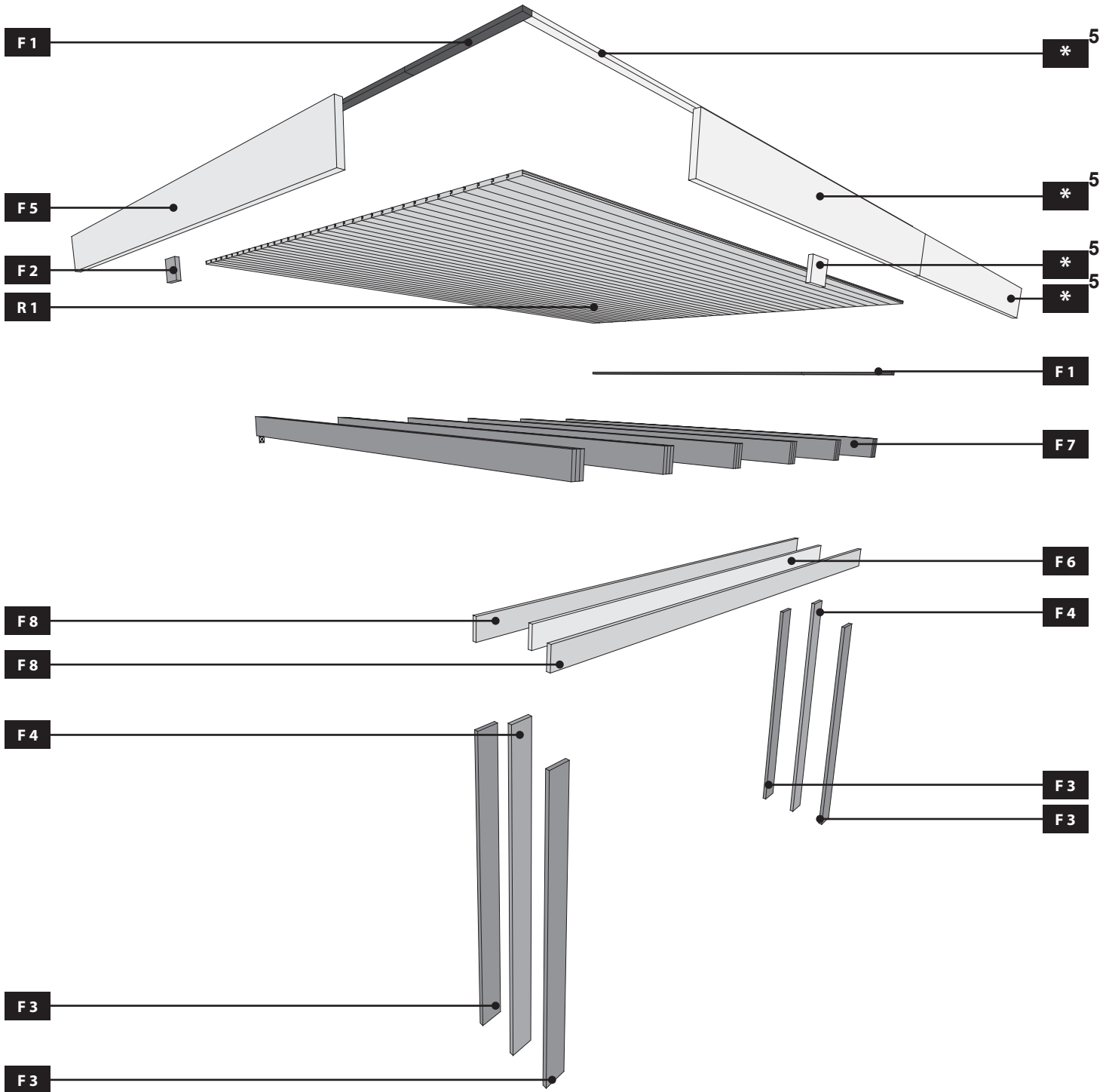

01 2x

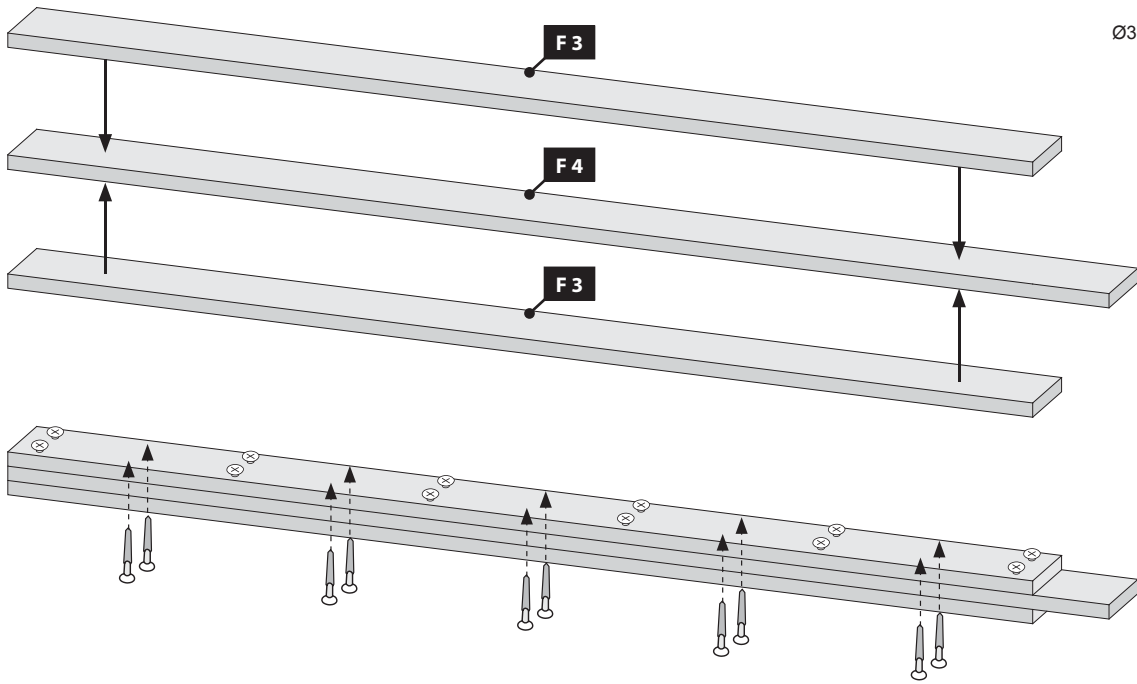

44x
Ø3 mm 4x70

02

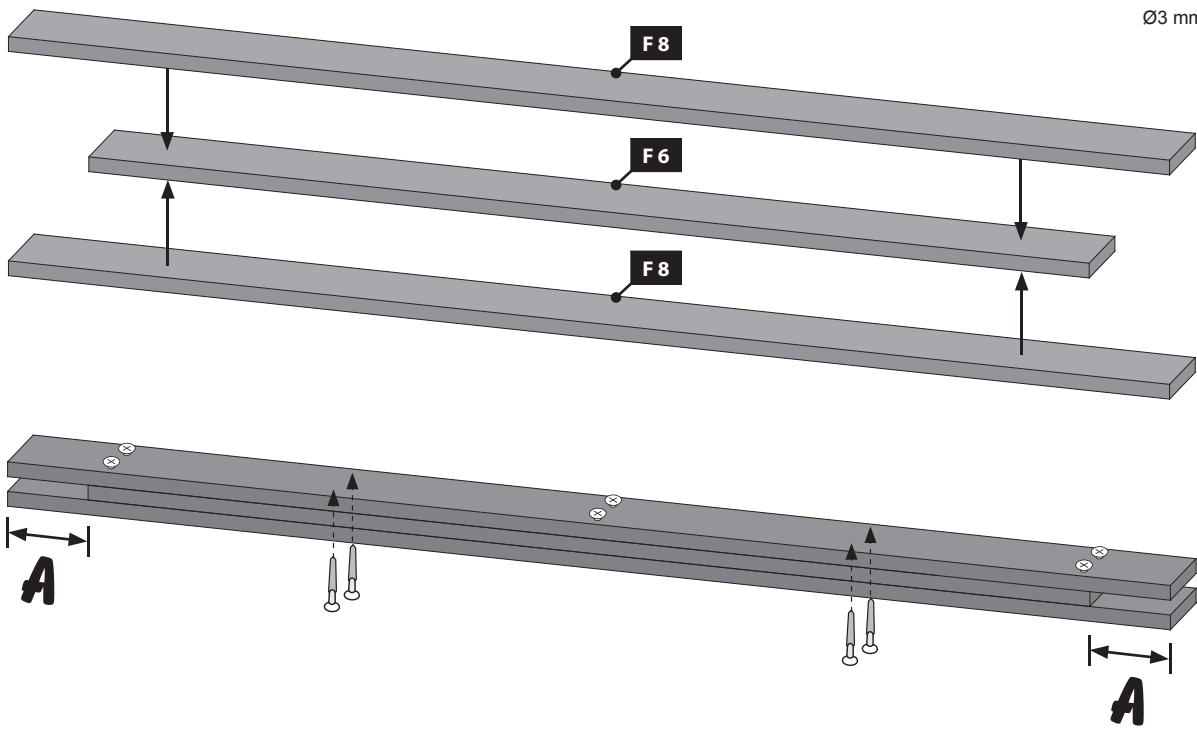





10x
Ø3 mm 4x70

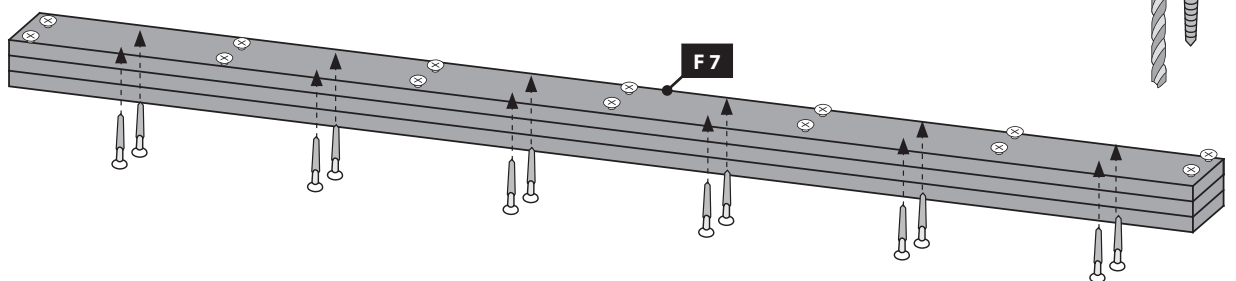



03 6x

-  Bündig!
-  Flush!
-  Affleurement!
-  Gelijk!
-  I flugt!
-  Aras!
-  Combacia!
-  Stejný !



156x
Ø3 mm 4x70

-  Länge muss ermittelt und zugesägt werden
-  Length must be determined and sawn
-  La longueur doit être déterminée et sciée
-  De lengte moet worden bepaald en worden gezaagd

-  La longitud debe ser determinada y aserrada
-  La lunghezza deve essere determinata e segata
-  Délka musí být určena a rozřezána
-  Længden skal bestemmes og savnes

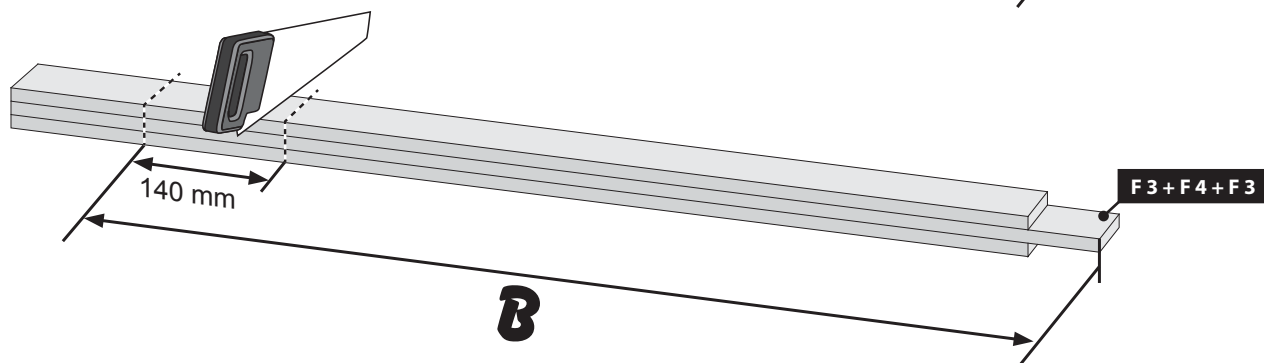
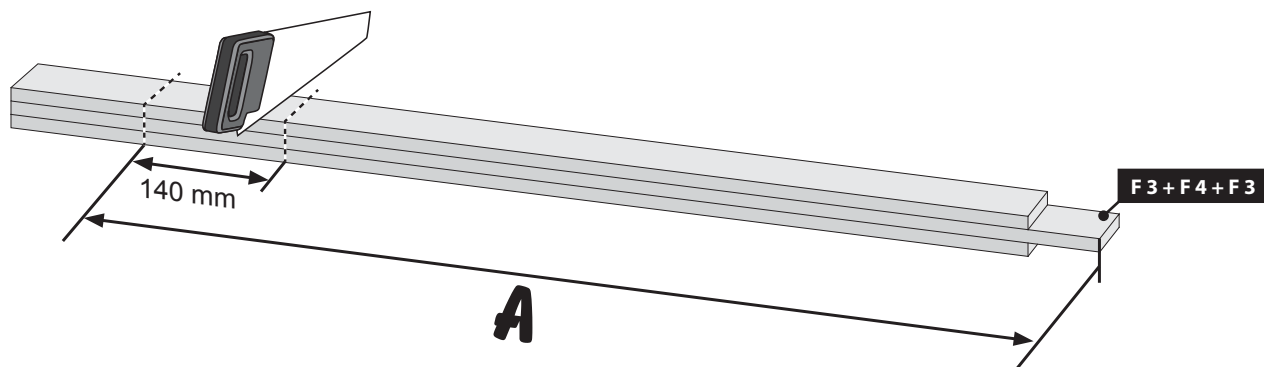
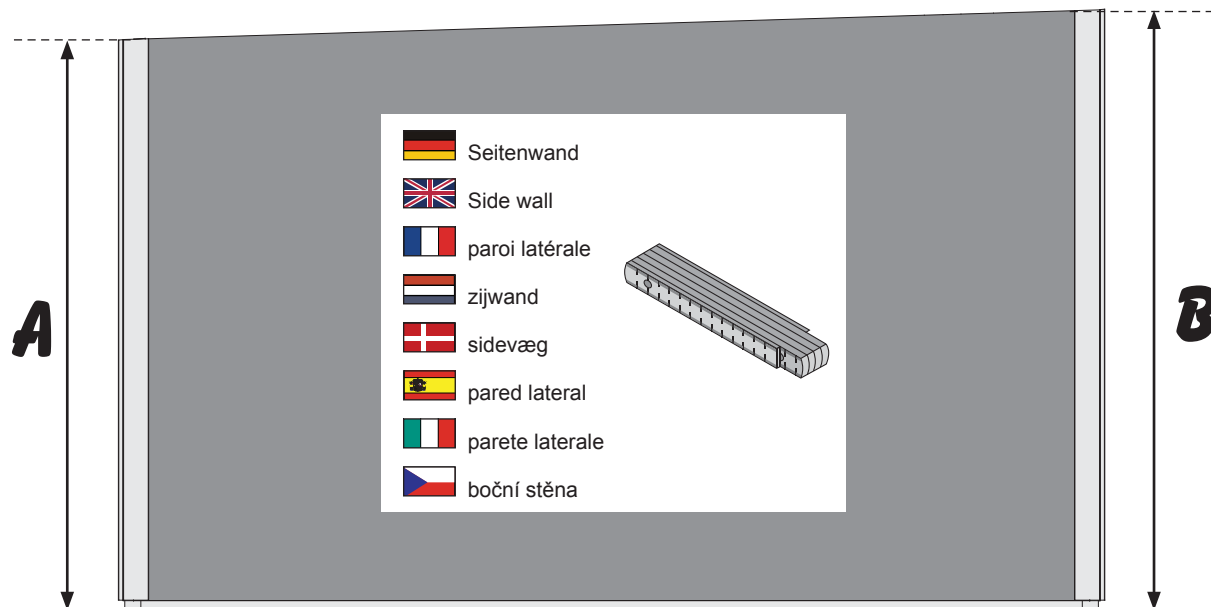

05

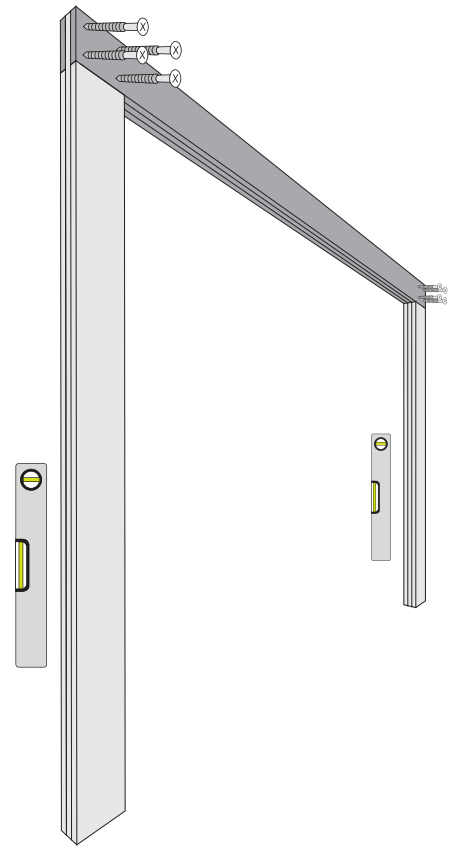
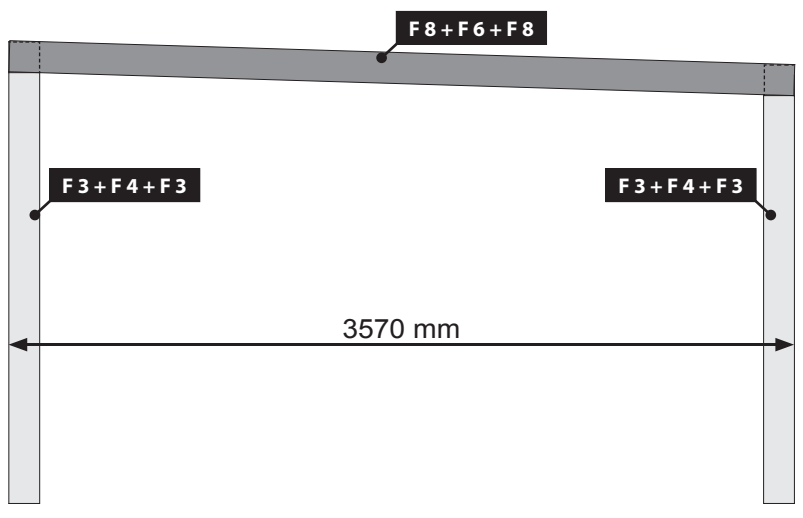
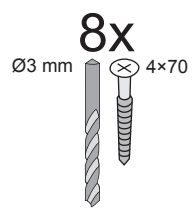

06

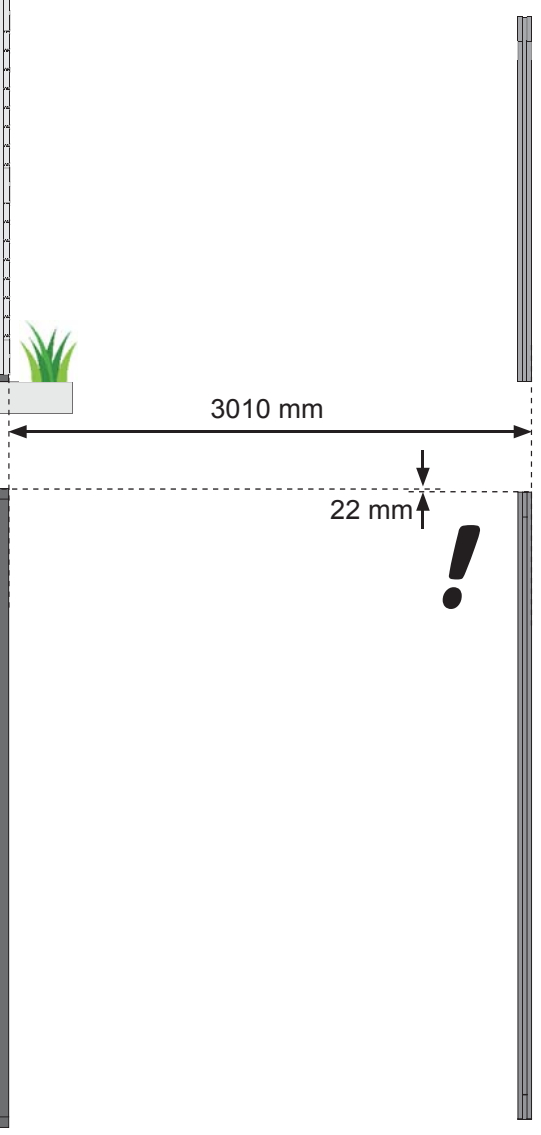
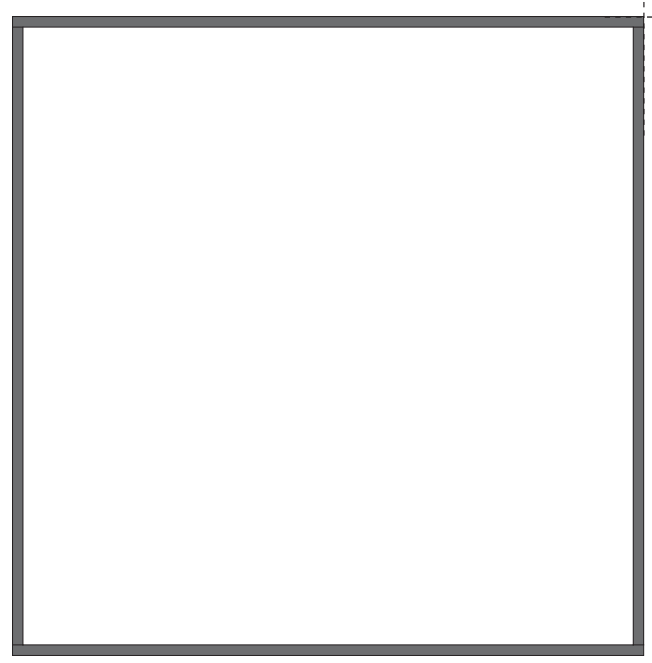
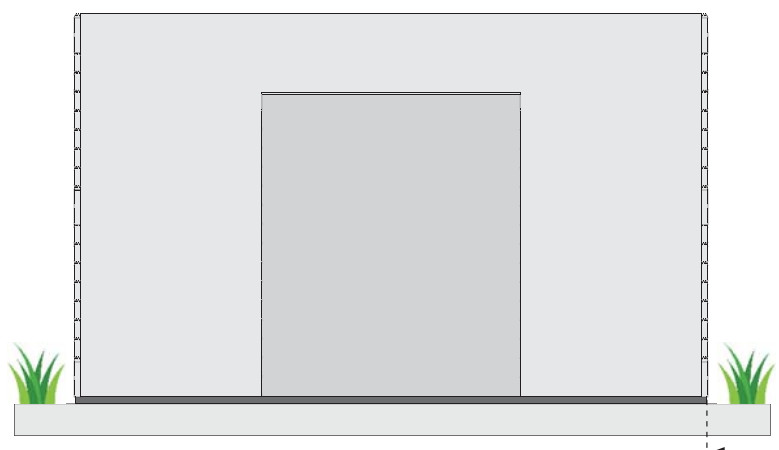

-  Bündig!
-  Flush!
-  Affleurement!
-  Gelijk!
-  I flugt!
-  Aras!
-  Combacia!
-  Stejný !

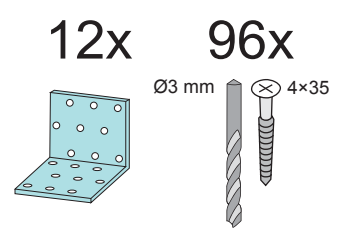
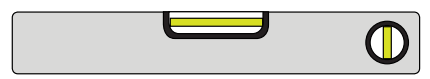
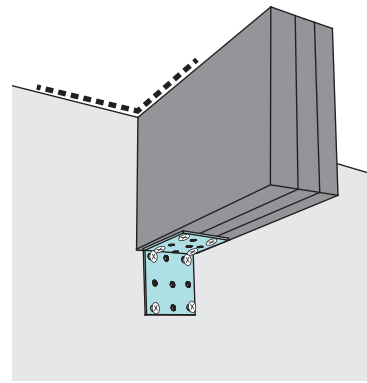

-  Draufsicht
-  Top view
-  vue de dessus
-  bovenaanzicht
-  vista desde arriba
-  vista desde arriba
-  vista dall'alto
-  púdorys

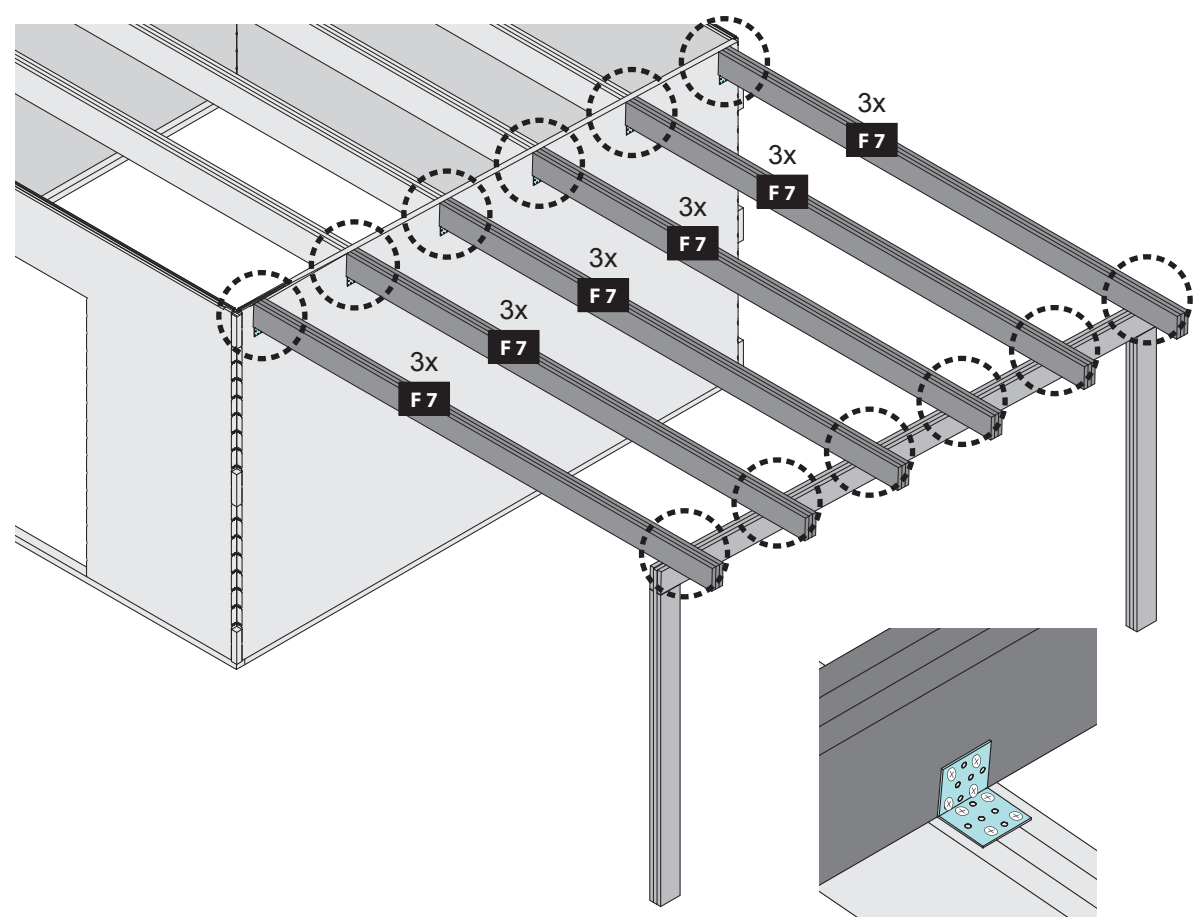
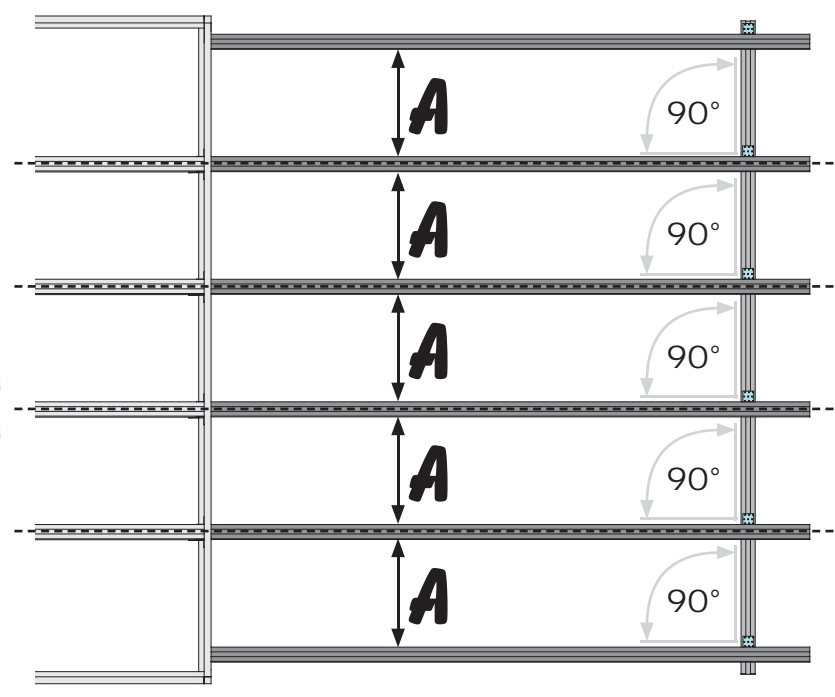

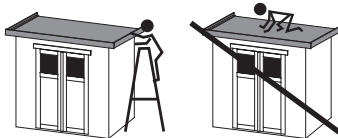

 Montage Dach

 Toit de montage

 Techo de montaje

 Montáž střechy

 Mounting roof

 Montage dak

 Tetto di montaggio

 Montering tag

08

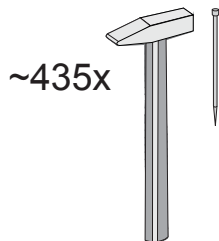

 Schmale Seite nach außen

 Narrow side out

 Côté étroit sur

 Smalle zijde out

 Lado estrecho hacia fuera



 Narrow lato fuori

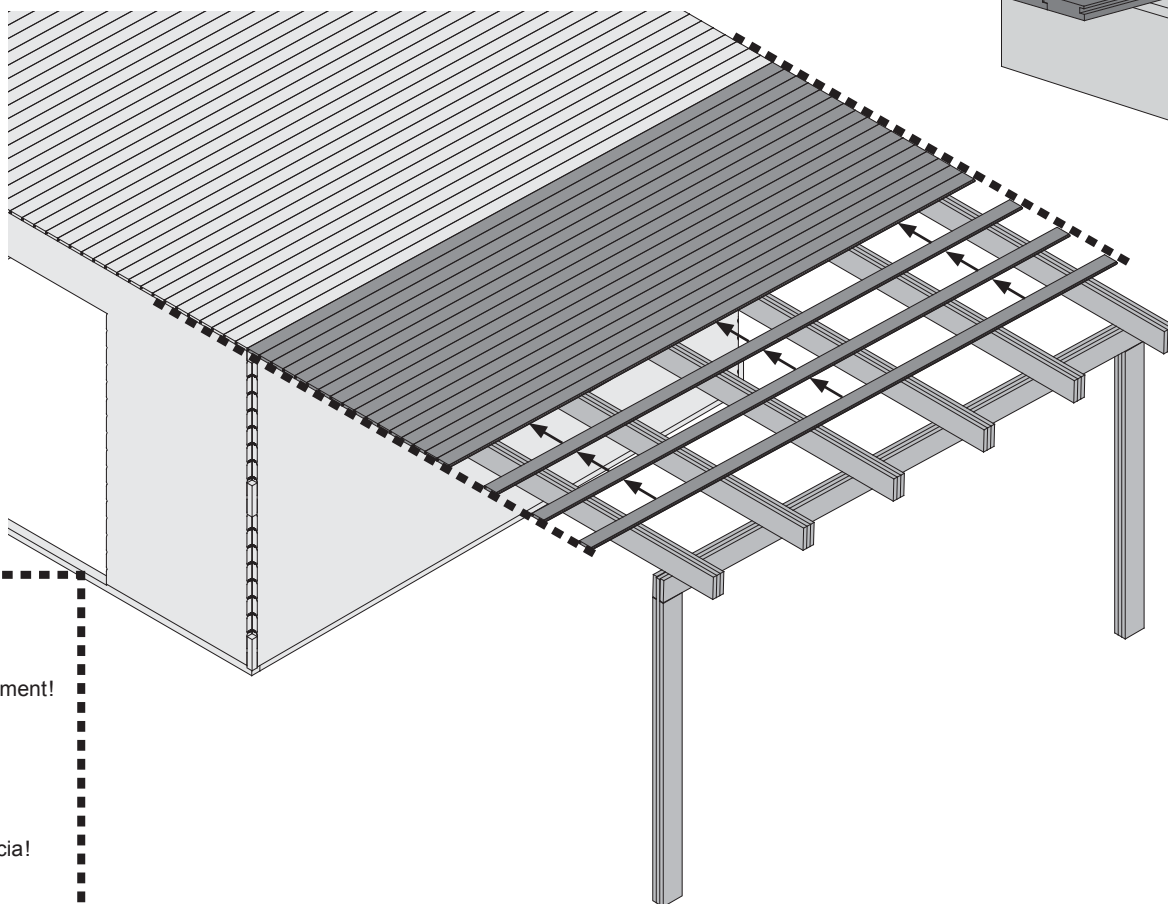
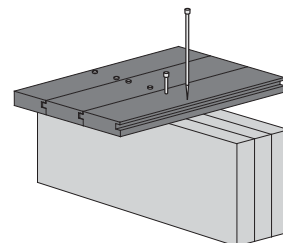
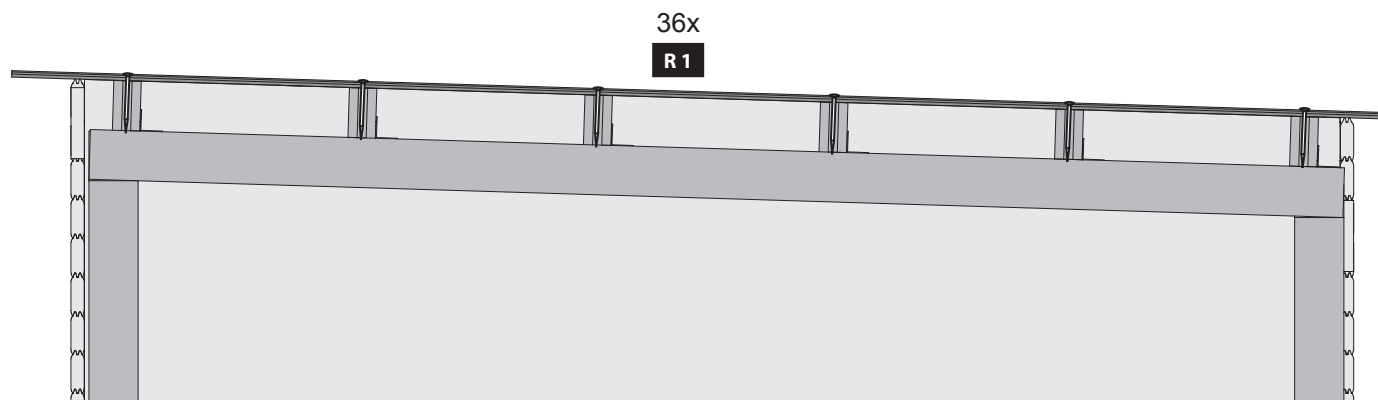

 Úzké boční out

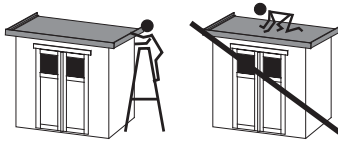





-  Bündig!
-  Flush!
-  Affleurement!
-  Gelijk!
-  I flugt!
-  Aras!
-  Combacia!
-  Stejný !



 Montage Dach
 Mounting roof





 Toit de montage
 Montage dak

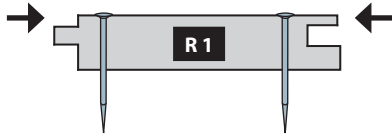

 Techo de montaje
 Tetto di montaggio

 Montáž střechy
 Montering tag

09



 Schmale Seite nach außen
 Narrow side out
 Côté étroit sur
 Smalle zijde out

 Lado estrecho hacia fuera
 Narrow lato fuori
 Úzké boční out

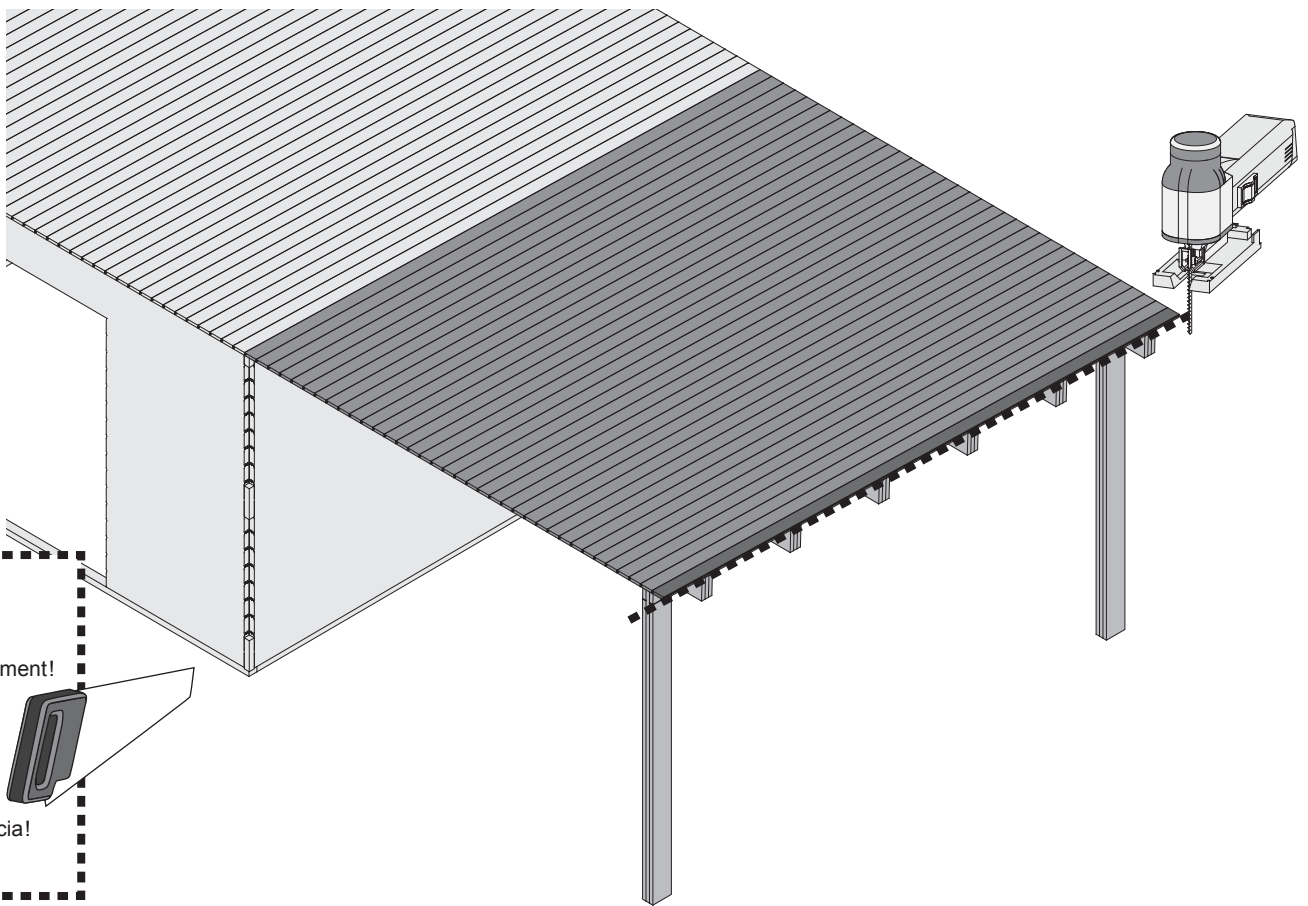
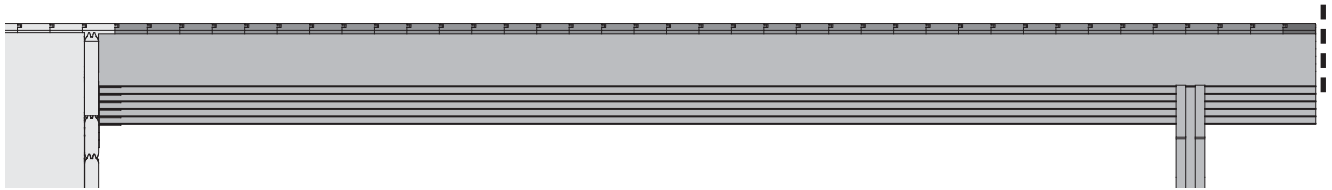

-  Bündig!
-  Flush!
-  Affleurement!
-  Gelijk!
-  I flugt!
-  Aras!
-  Combacia!
-  Stejný !

10

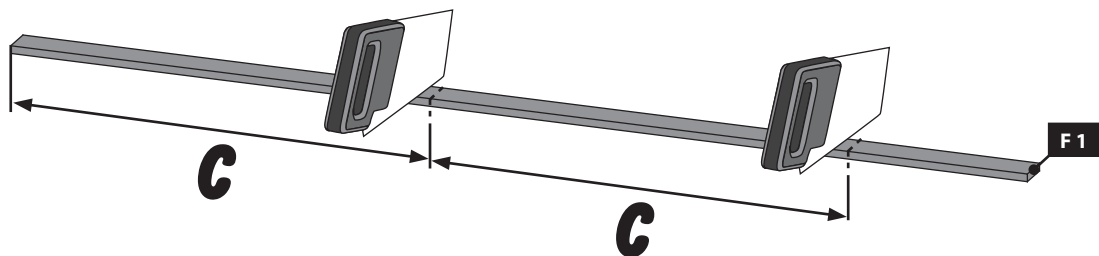

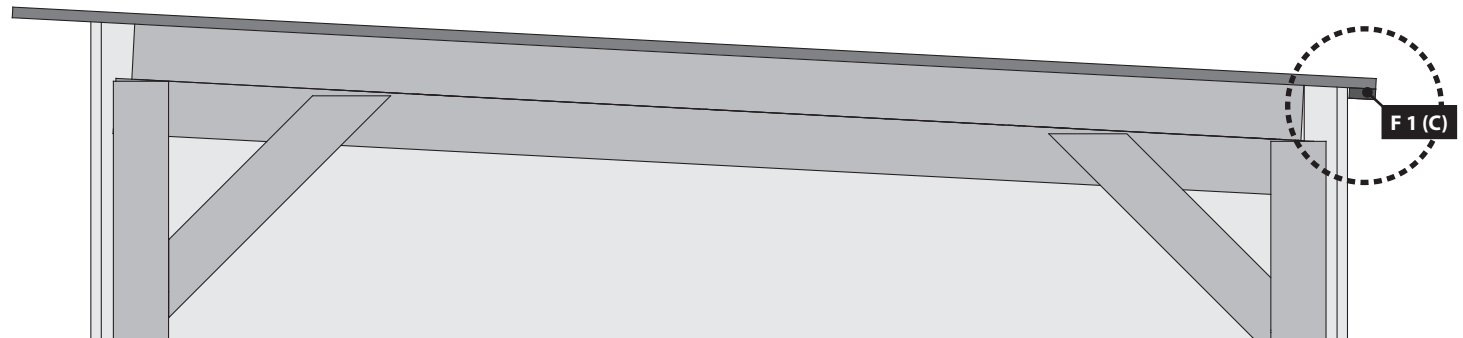
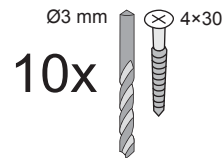
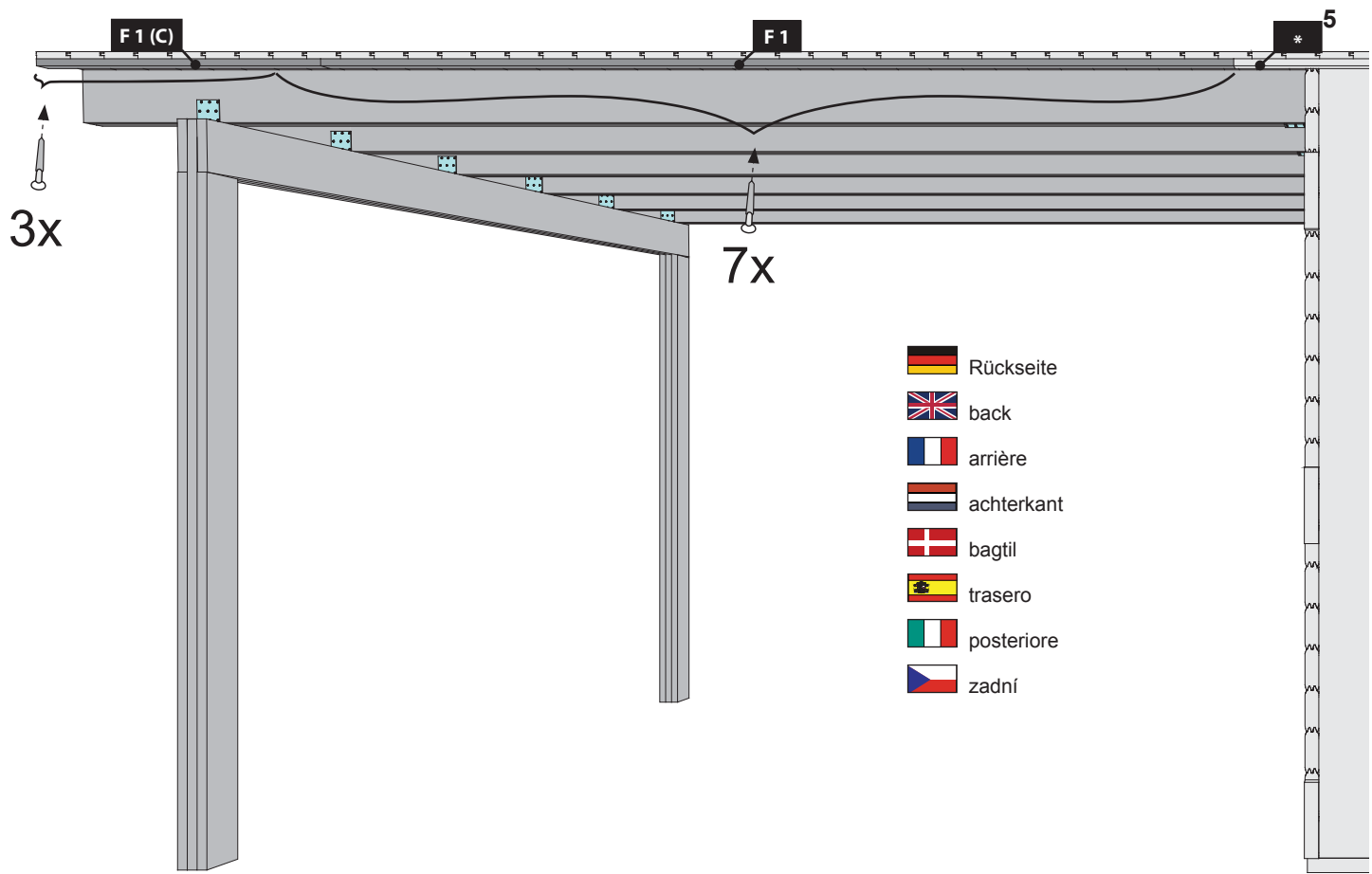

Wichtige Hinweise:

Bitte lesen Sie diese Hinweise sorgfältig durch, bevor Sie mit dem Zusammenbau beginnen. Diese Hinweise sind für Ihre Sicherheit und die Qualität der Montage entscheidend. Bitte beachten Sie, dass die Montageanleitung in mehreren Sprachen verfügbar ist. Bitte lesen Sie die Anleitung in Ihrer Muttersprache.

1. Sicherheit: Achten Sie auf die richtige Montage der Stühle, um Verletzungen zu vermeiden. Verwenden Sie die richtigen Werkzeuge und Techniken.

2. Materialschonung: Handhabung der Bauteile vorsichtig, um Beschädigungen zu vermeiden. Verwenden Sie keine Gewalt.

3. Montageort: Wählen Sie einen ebenen, trockenen und gut belüfteten Ort für die Montage.

4. Werkzeuge: Benötigte Werkzeuge sind in der Liste der benötigten Werkzeuge aufgeführt. Bitte stellen Sie sicher, dass Sie diese Werkzeuge zur Verfügung haben.

5. Montagehinweise: Bitte lesen Sie die Montagehinweise sorgfältig durch, bevor Sie mit der Montage beginnen. Bitte beachten Sie die Reihenfolge der Montage.

6. Garantie: Die Garantie gilt nur bei korrekter Montage. Bitte bewahren Sie die Originalverpackung und die Montageanleitung auf.

7. Kontakt: Bei Fragen oder Problemen wenden Sie sich bitte an unseren Kundendienst. Bitte haben Sie Ihre Bestellnummer und die Details des Problems parat.

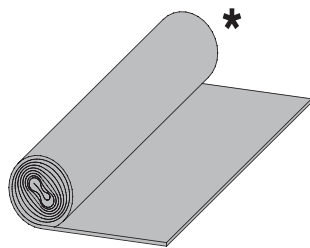
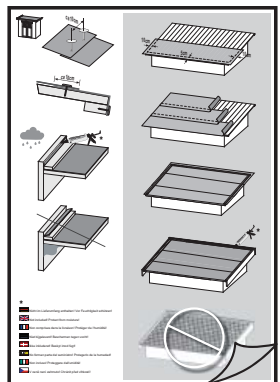

- ***
- Nicht im Lieferumfang enthalten
- Not included
- Non comprises dans la livraison
- Niet bijgeleverd
- No forman parte del suministro
- Non incluso
- V ceně není zahrnuto
- Ikke inkluderet

12

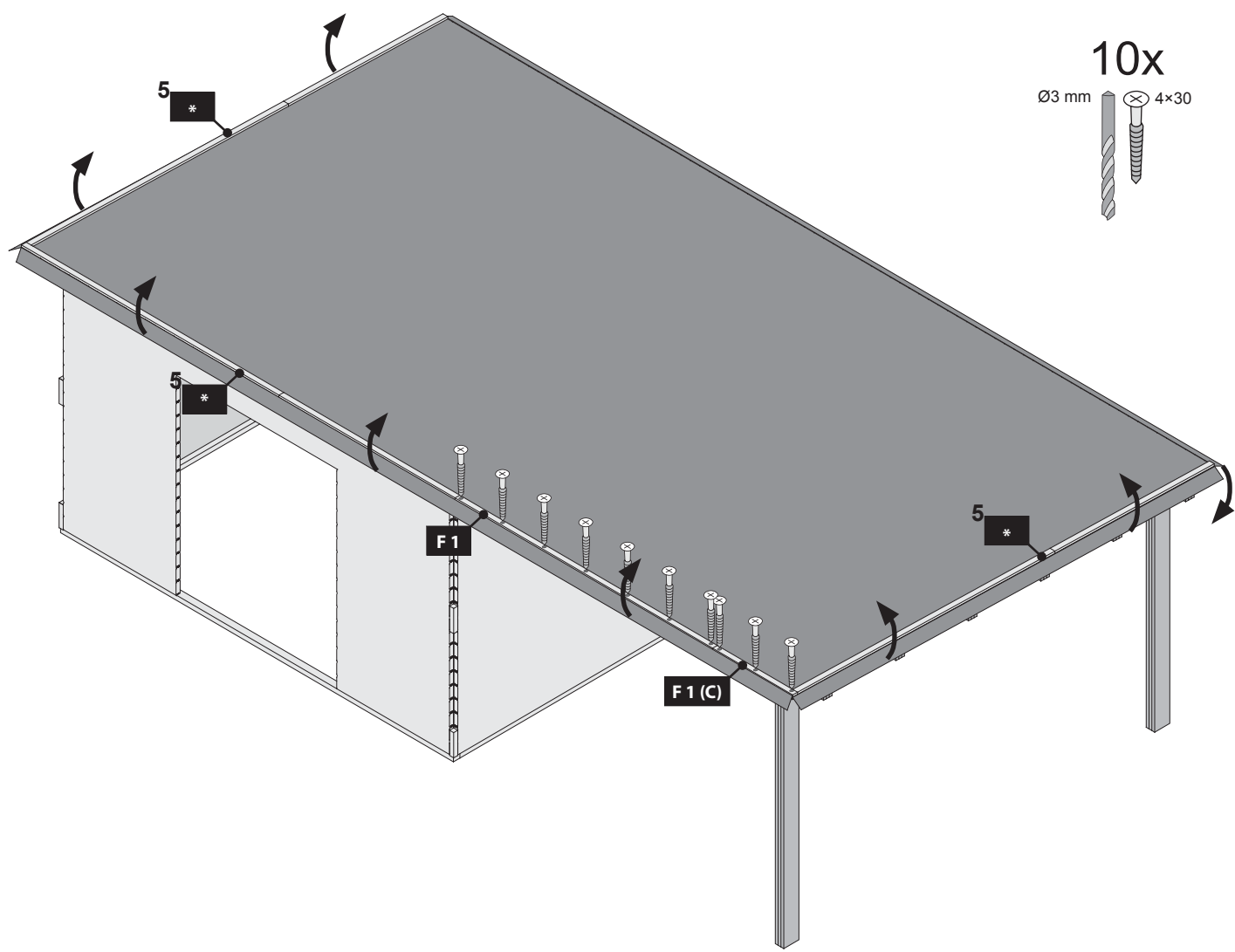

13

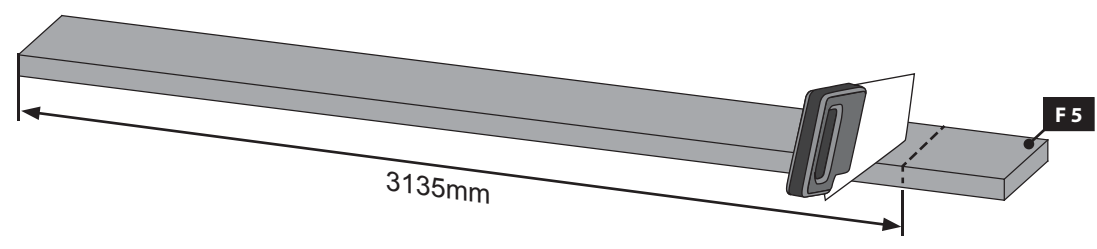

14

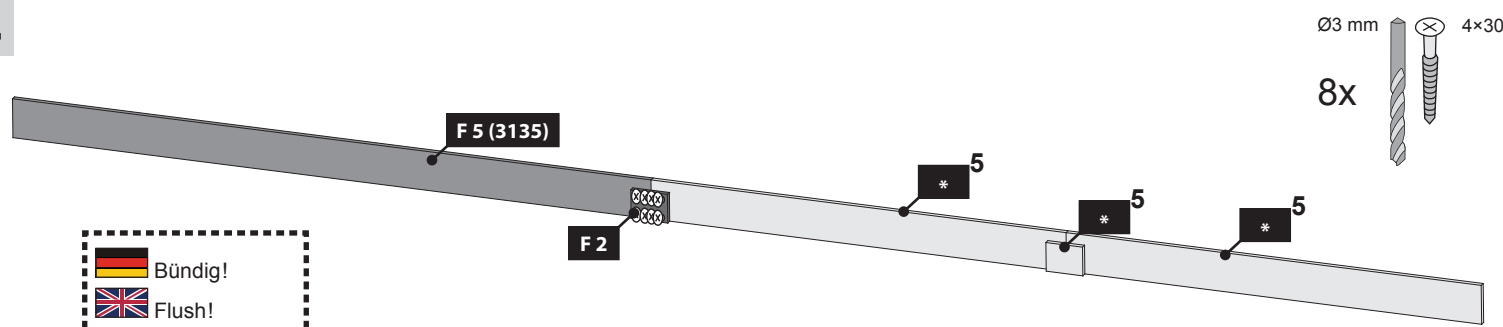

-  Bündig!
-  Flush!
-  Affleurement!
-  Gelijk!
-  I flugt!
-  Aras!
-  Combacia!
-  Stejný !

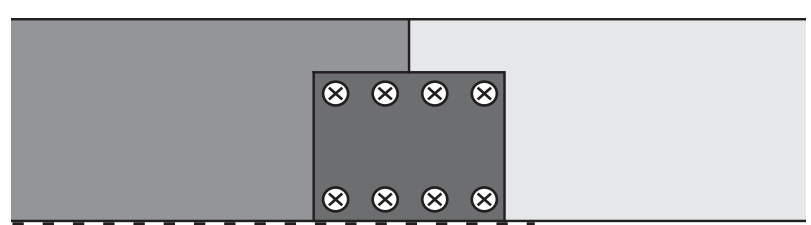

Ø3 mm 4x50

7x

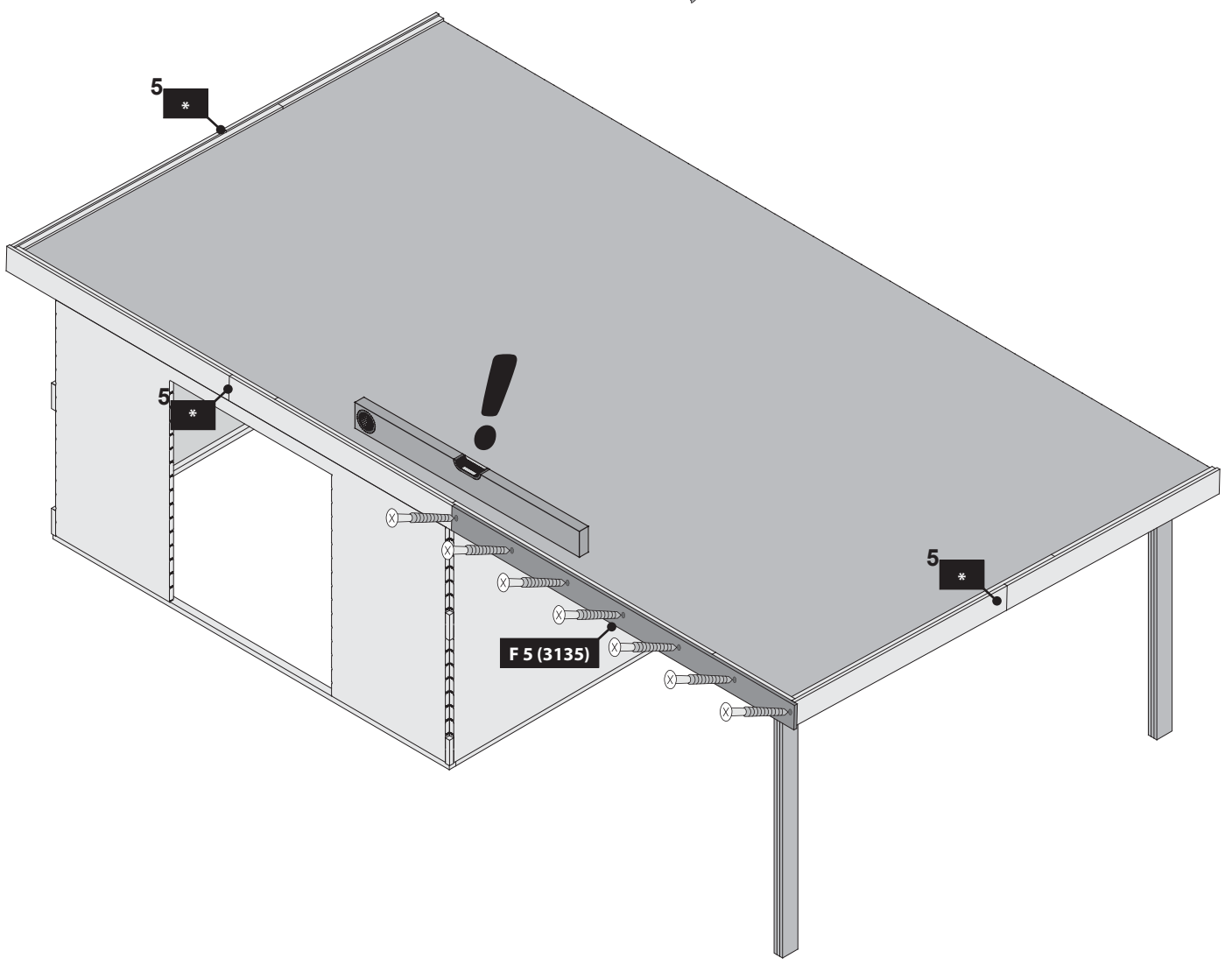
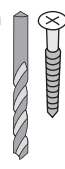

-  Bündig!
-  Flush!
-  Affleurement!
-  Gelijk!
-  I flugt!
-  Aras!
-  Combacia!
-  Stejný !

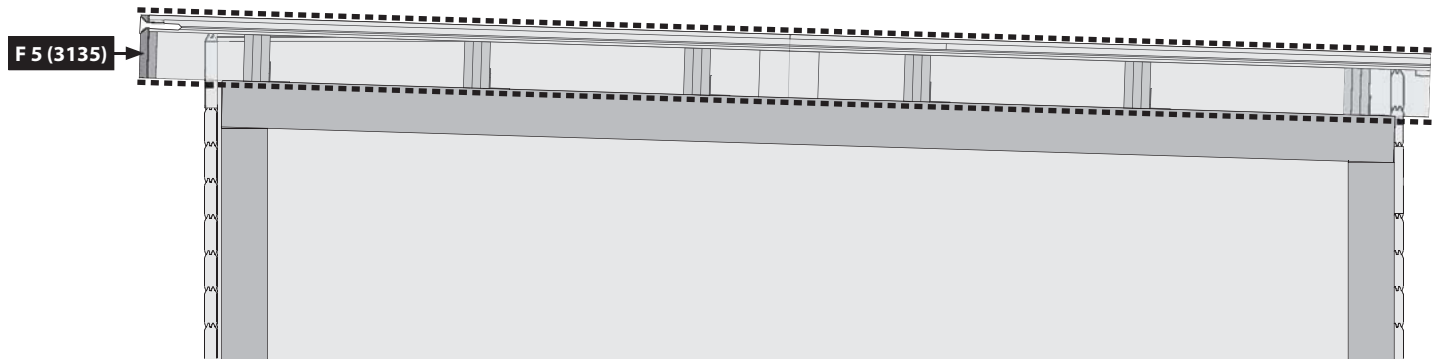

31310 31311





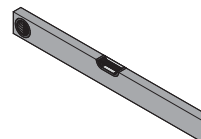
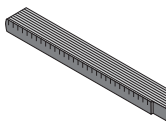
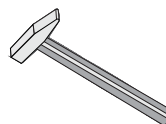
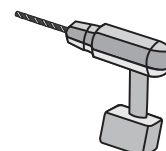
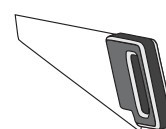

-  **Aufbauanleitung**
-  **Building Instructions**
-  **notice de montage**
-  **montagehandleiding**
-  **Montagevejledning**
-  **Instrucciones de construcción**
-  **Istruzioni per il montaggio**
-  **Montážní návod**











 Bitte bewahren Sie die Anleitung und den Garantieschein zur Seriennummer auf. Vernichten Sie diese erst nach Ablauf der Garantiezeit. Eventuelle Beanstandungen können mithilfe der Stückliste einfacher zugeordnet werden.





Beigelegte Dokumente:

- Informationsheft
- Garantieschein zur Seriennummer
- Typenschild inkl. Warnhinweise (Sauna)
- ggf. Zubehör-Anleitungen in externen Paketen

- *  Nicht im Lieferumfang enthalten
 Not included
 Non comprises dans la livraison
 Niet bijgeleverd



-  No forman parte del suministro
 Non incluso
 V ceně není zahrnuto
 Ikke inkluderet

- 1  Länge muss ermittelt und zugesägt werden
 Length must be determined and sawn
 La longueur doit être déterminée et sciée
 De lengte moet worden bepaald en worden gezaagd

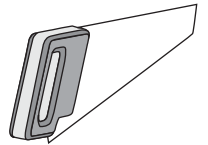
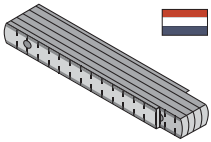
-  La longitud debe ser determinada y aserrada
 La lunghezza deve essere determinata e segata
 Délka musí být určena a rozřezána
 Længden skal bestemmes og saves



- 2  Nicht gebraucht
 Not needed
 Pas nécessaire
 Niet nodig



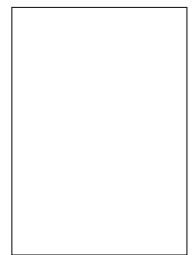

-  No es necesario
 Non necessario
 Není nutná

- 3  mit Zubehör!
 met toebehoren!
 with accessories!
 avec accessoires!





-  con accesorios!
 con accessori!
 s příslušenstvím!
 z dodatki!



- 4  Fixiert vorübergehend
 tijdelijk vast
 Fixed temporarily
 temporairement fixe

-  temporalmente fijo
 temporaneamente fisso
 dočasně pevný
 Zčasno pritrjeno

- 5  Bestand vom Haus
 Inventaris van het huis
 Inventory of the house
 Inventaire de la maison

-  Inventario de la casa
 Inventario della casa
 Inventář domu
 Inventar hiše

Werkzeuge / Tools*

X

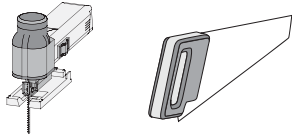

X

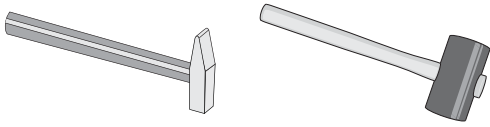

X

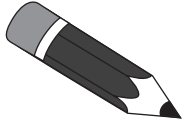

X

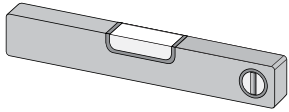

X

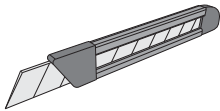

X

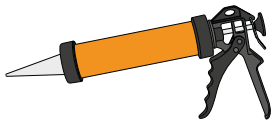
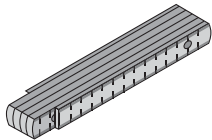

X



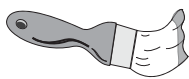
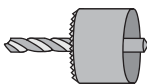
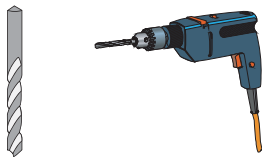

X





X





 Vergleichen Sie zuerst die Material-liste mit Ihrem Paketinhalt! Bitte haben Sie Verständnis, dass Beanstandungen nur im nicht aufgebauten Zustand bearbeitet werden können!

 Vergelijk eerst de lijst van materialen met de inhoud van uw pakket! Reclamaties kunnen alleen in behandeling worden genomen zolang de onderdelen nog niet zijn gemonteerd!

 Confrontate questa distinta materiali prima con il contenuto del pacchetto! Vi preghiamo di comprendere che eventuali reclami possono essere accolti solo prima del montaggio!

 First compare the list of materials with your package contents! Please understand that complaints can be processed in the non-built status only!

 Start med at kontrollere materialelisten med indholdet af den leverede pakke! Vi gør venligst opmærksom på at reklamationer kun kan behandles for materialer som ikke er blevet bearbejdet!

 Nejprve přezkontrolujte obsah balení podle materiálového listu! Mějte pochopení pro to, že případnou reklamaci se můžeme zabývat pouze tehdy, když díly nebudou smontované! Za pomoci tohoto seznamu můžete jednotlivé díly přiřadit k montážnímu návodu.

 Commencez par comparer la liste du matériel avec le contenu de votre paquet! Sachez que nous traitons uniquement les réclamations concernant le matériel à l'état non monté!

 En primer lugar, compare la lista de material con el contenido del paquete. Rogamos entienda que las reclamaciones sólo pueden ser tramitadas antes de montar el objeto!

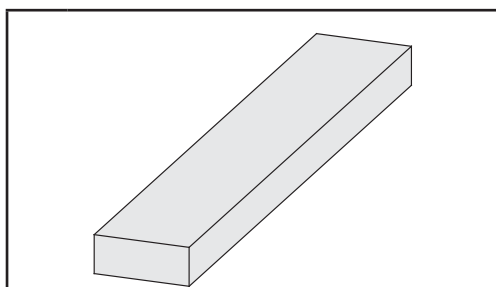
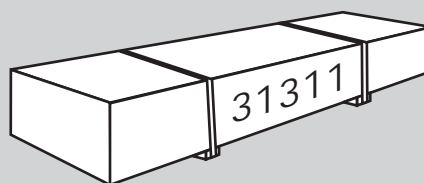
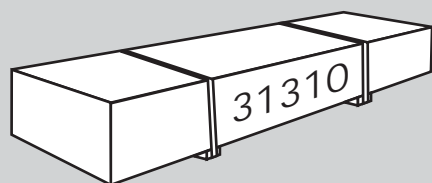

1 x Z1	2100 x 95 x 18 mm	ID 11427
1 x Z2	3090 x 60 x 40 mm	ID 28694
2 x Z3	2100 x 45 x 45 mm	ID 59046

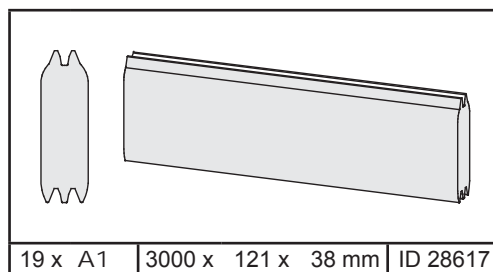

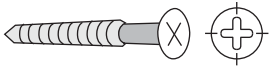

19 x A1	3000 x 121 x 38 mm	ID 28617
---------	--------------------	----------

		
35 x	4 x 30 mm	ID 3686
80 x	4 x 50 mm	ID 3688
15 x	4 x 70 mm	ID 3689

 Übersicht
 Overview
 enquête

 overzicht
 undersøgelse
 estudio

 sondaggio
 přehled

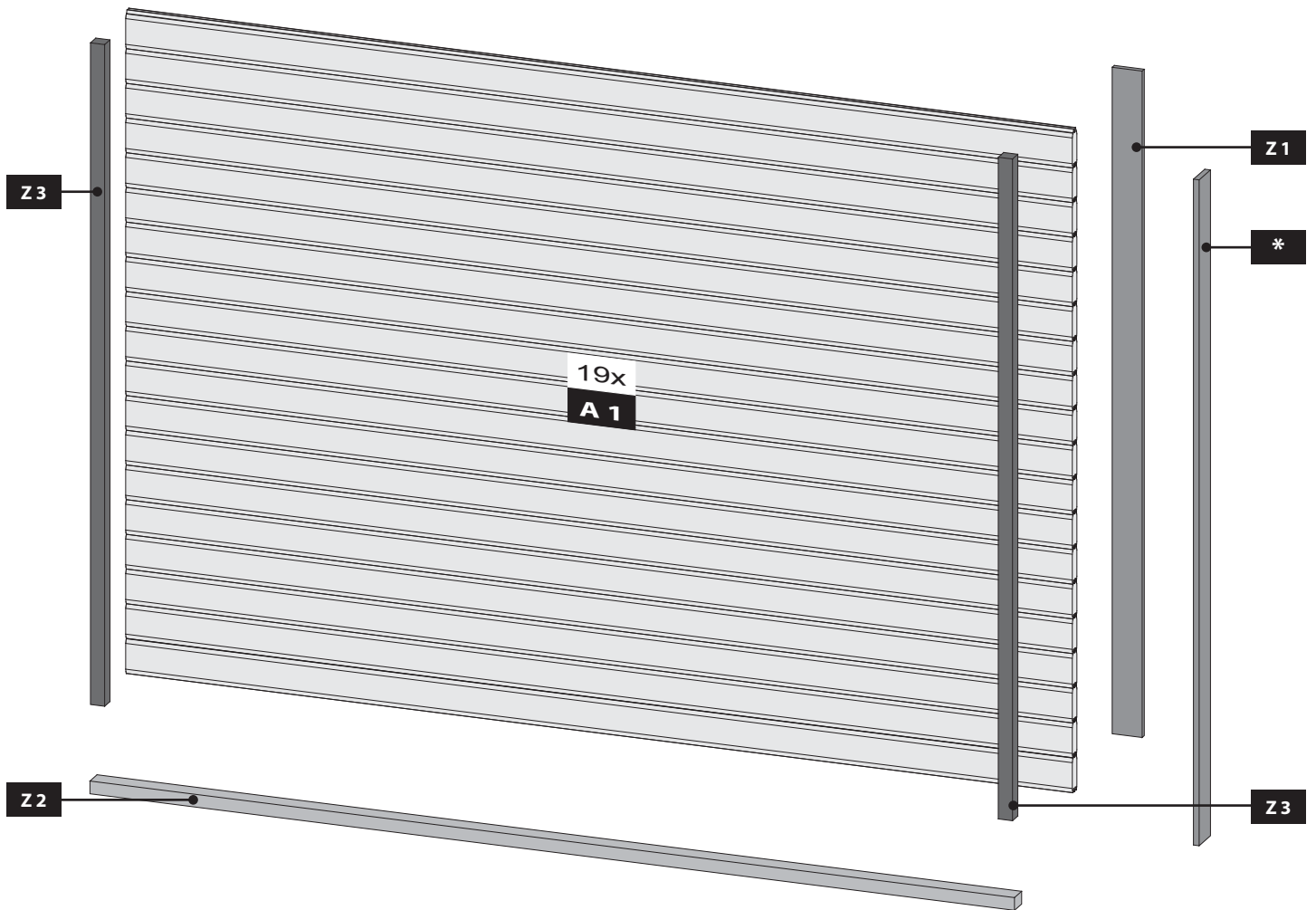



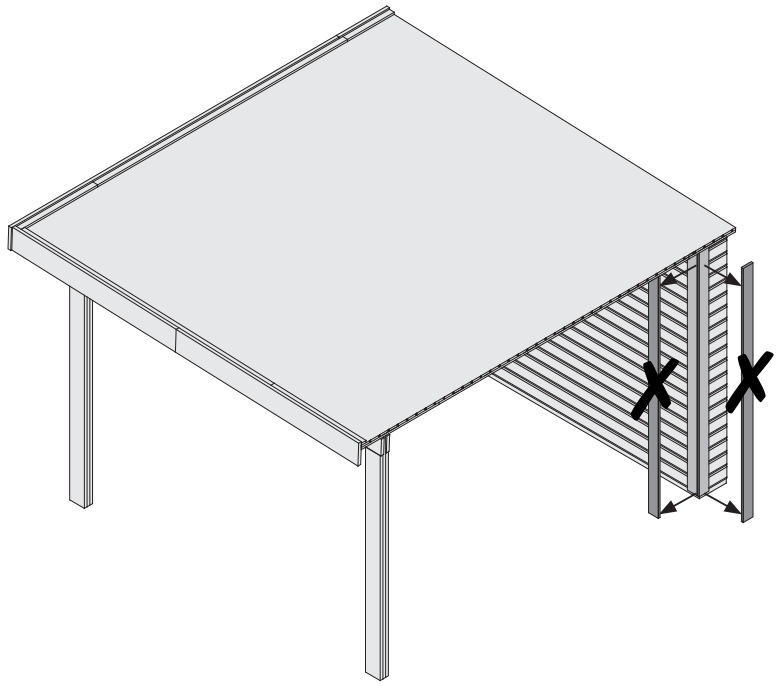



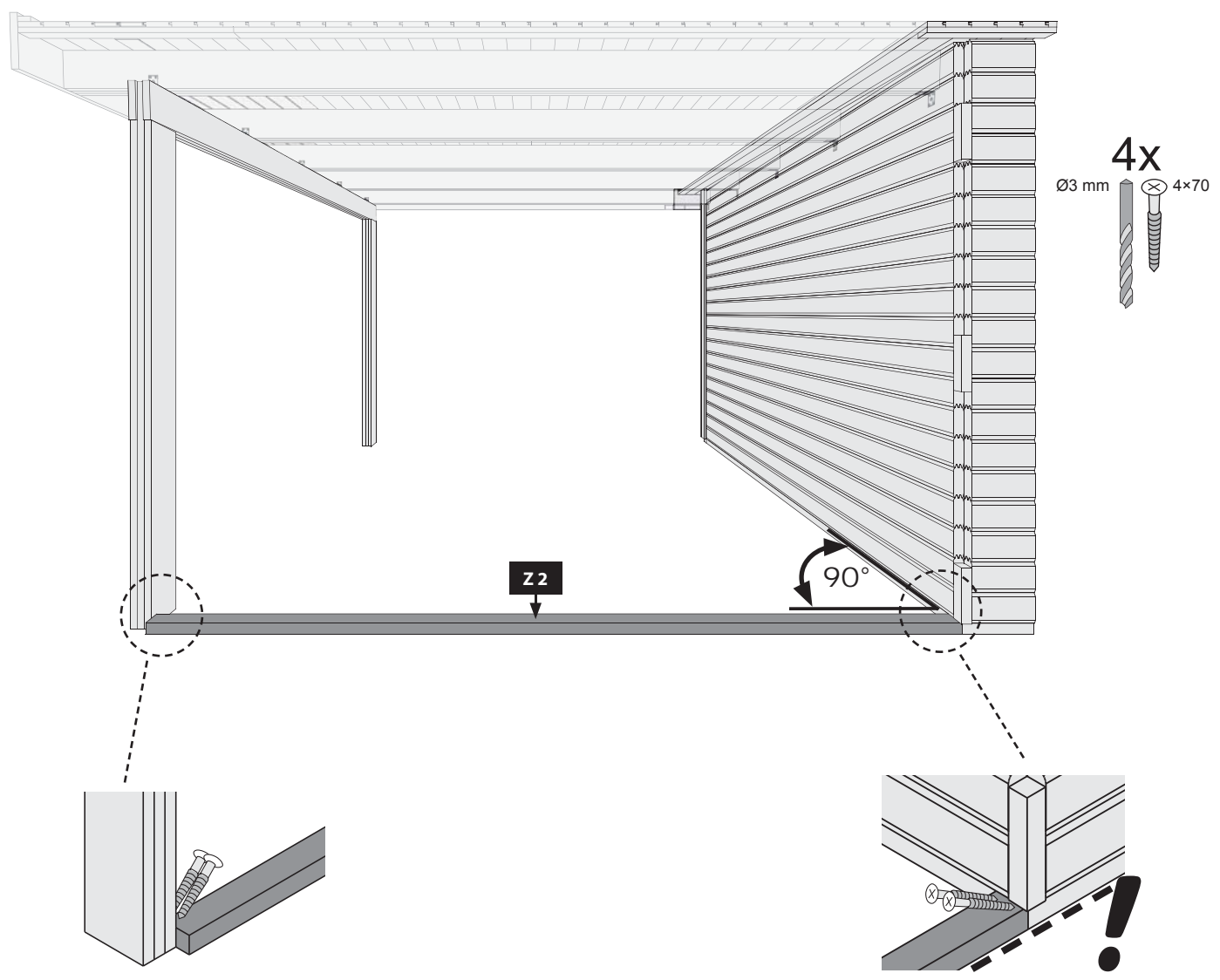

01



02



-  Länge muss ermittelt und zugesägt werden
-  Length must be determined and sawn
-  La longueur doit être déterminée et sciée
-  De lengte moet worden bepaald en worden gezaagd

-  La longitud debe ser determinada y aserrada
-  La lunghezza deve essere determinata e segata
-  Délka musí být určena a rozřezána
-  Længden skal bestemmes og saves

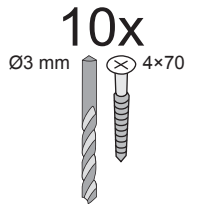
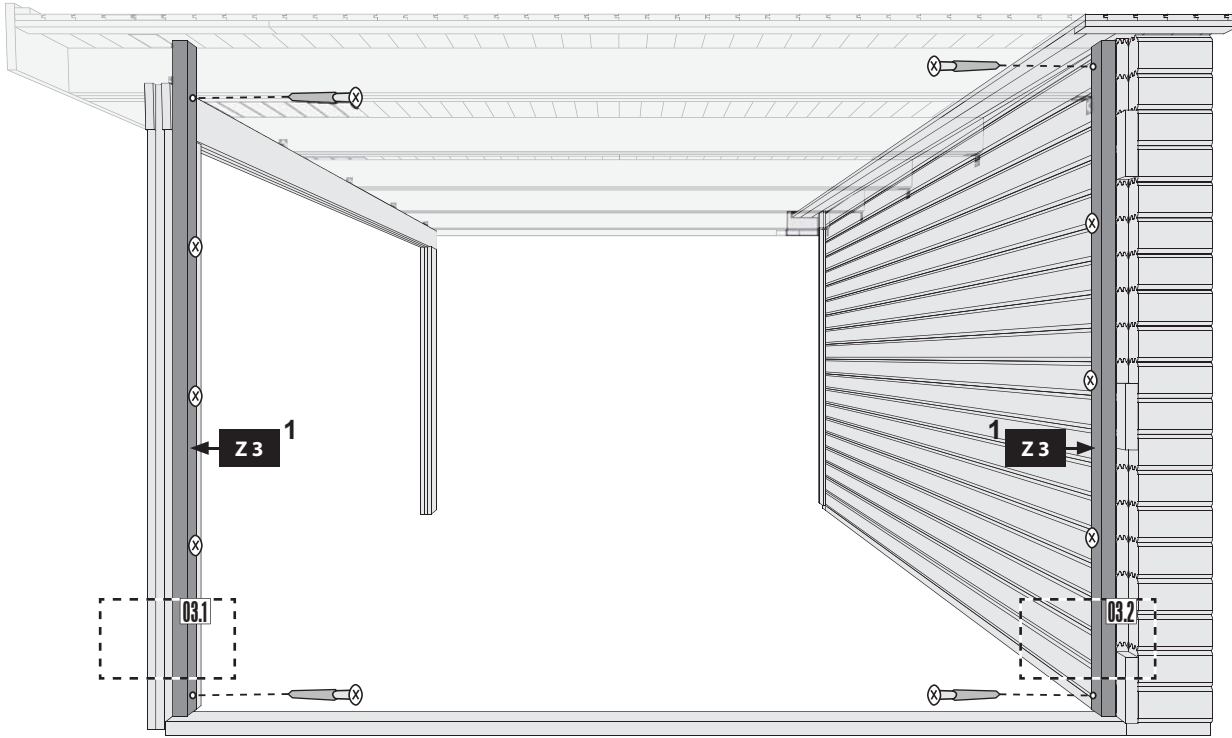
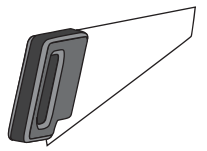

03.1

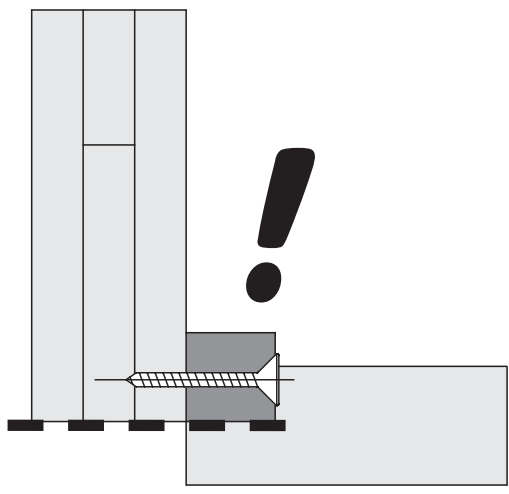

-  Bündig!
-  Flush!
-  Affleurement!
-  Gelijk!
-  I flugt!
-  Aras!
-  Combacia!
-  Stejný !

03.2

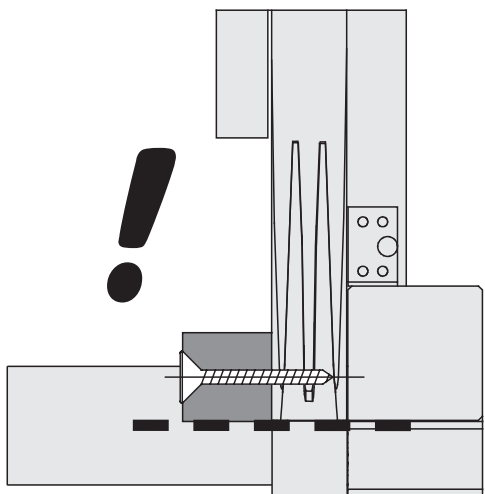

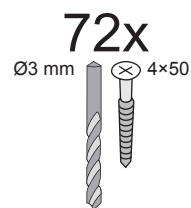
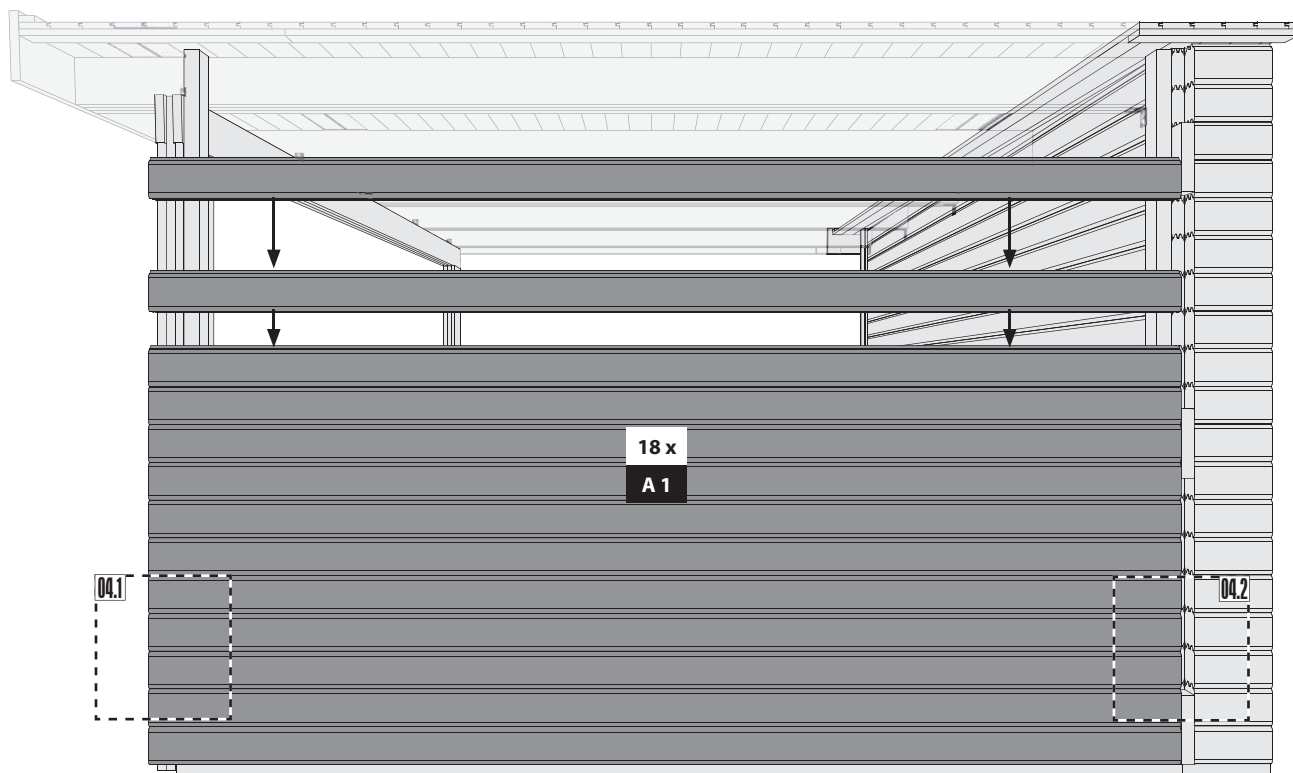

04.1

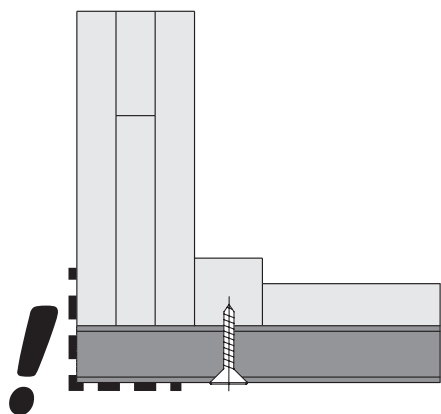
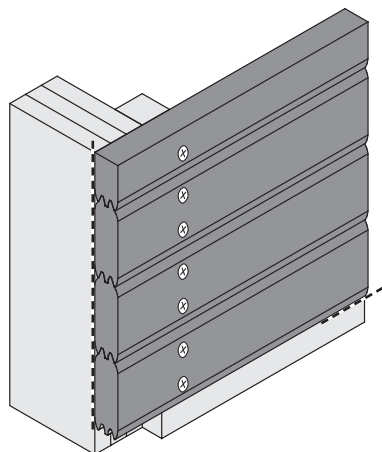

04.2

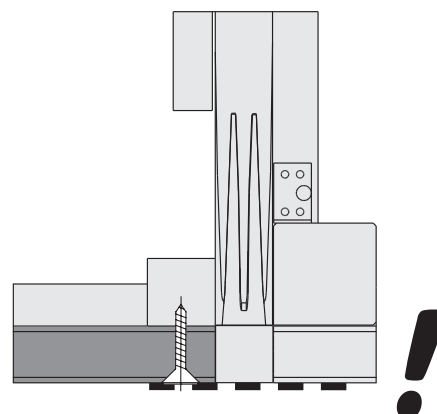
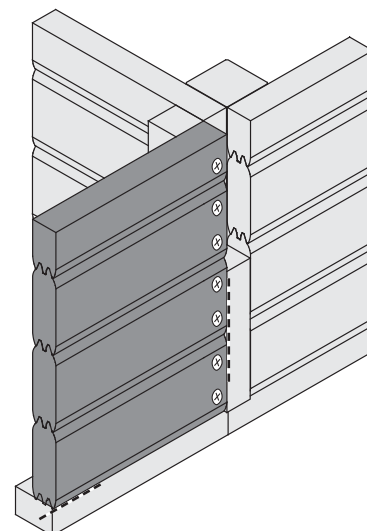

-  Bündig!
-  Flush!
-  Affleurement!
-  Gelijk!
-  I flugt!
-  Aras!
-  Combacia!
-  Stejný !

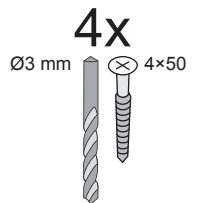
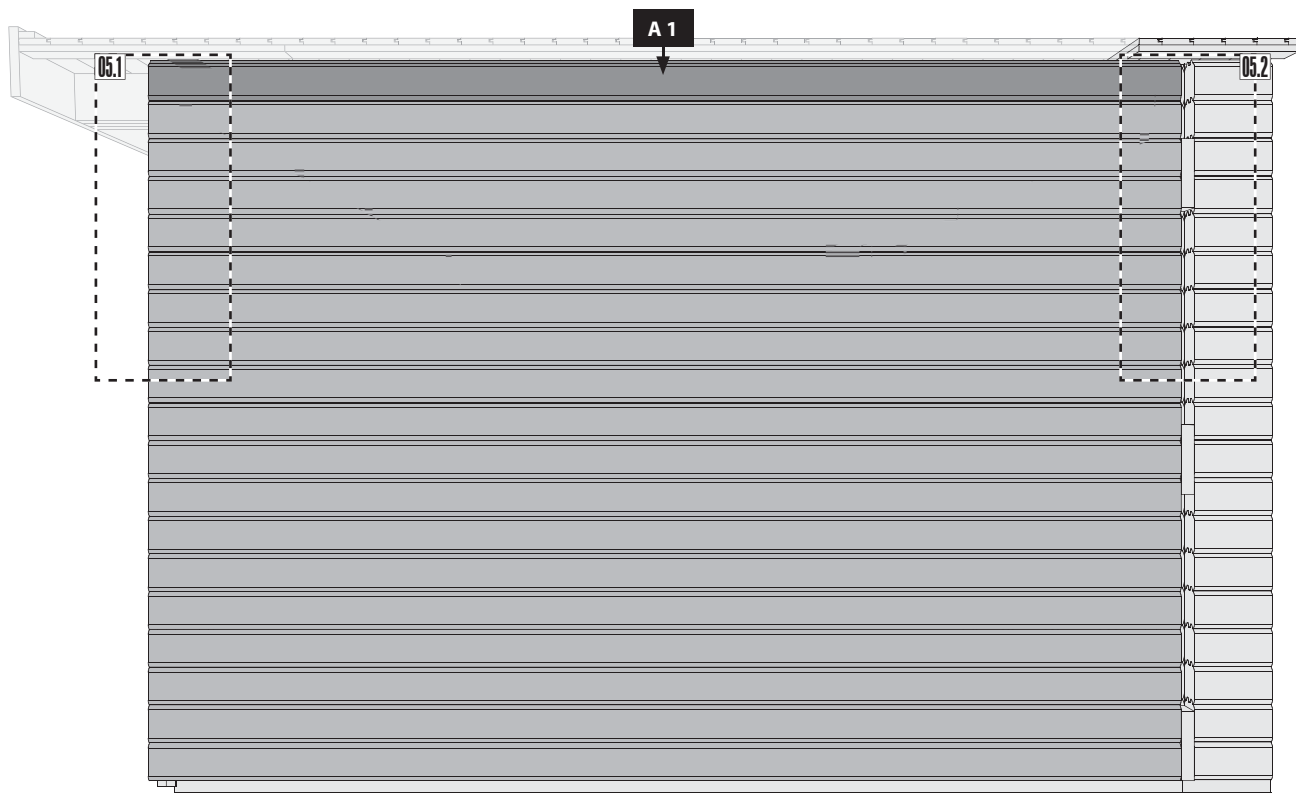

05.1

05.2

-  Bündig!
-  Flush!
-  Affleurement!
-  Gelijk!
-  I flugt!
-  Aras!
-  Combacia!
-  Stejný !

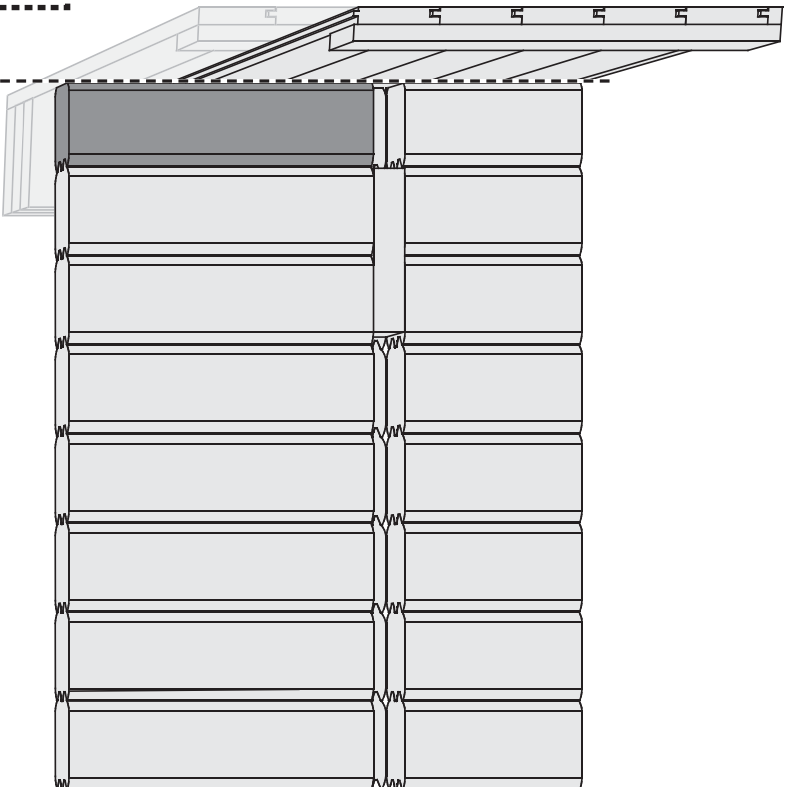
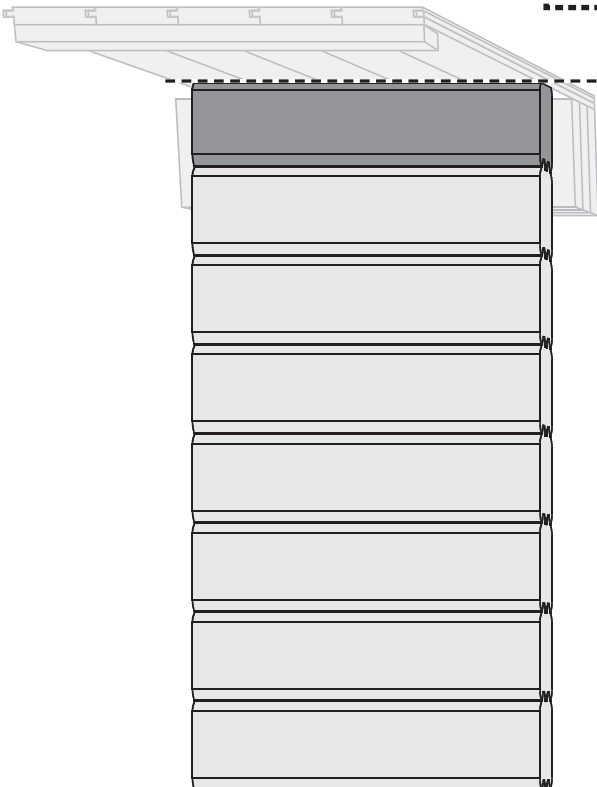
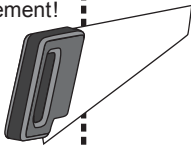

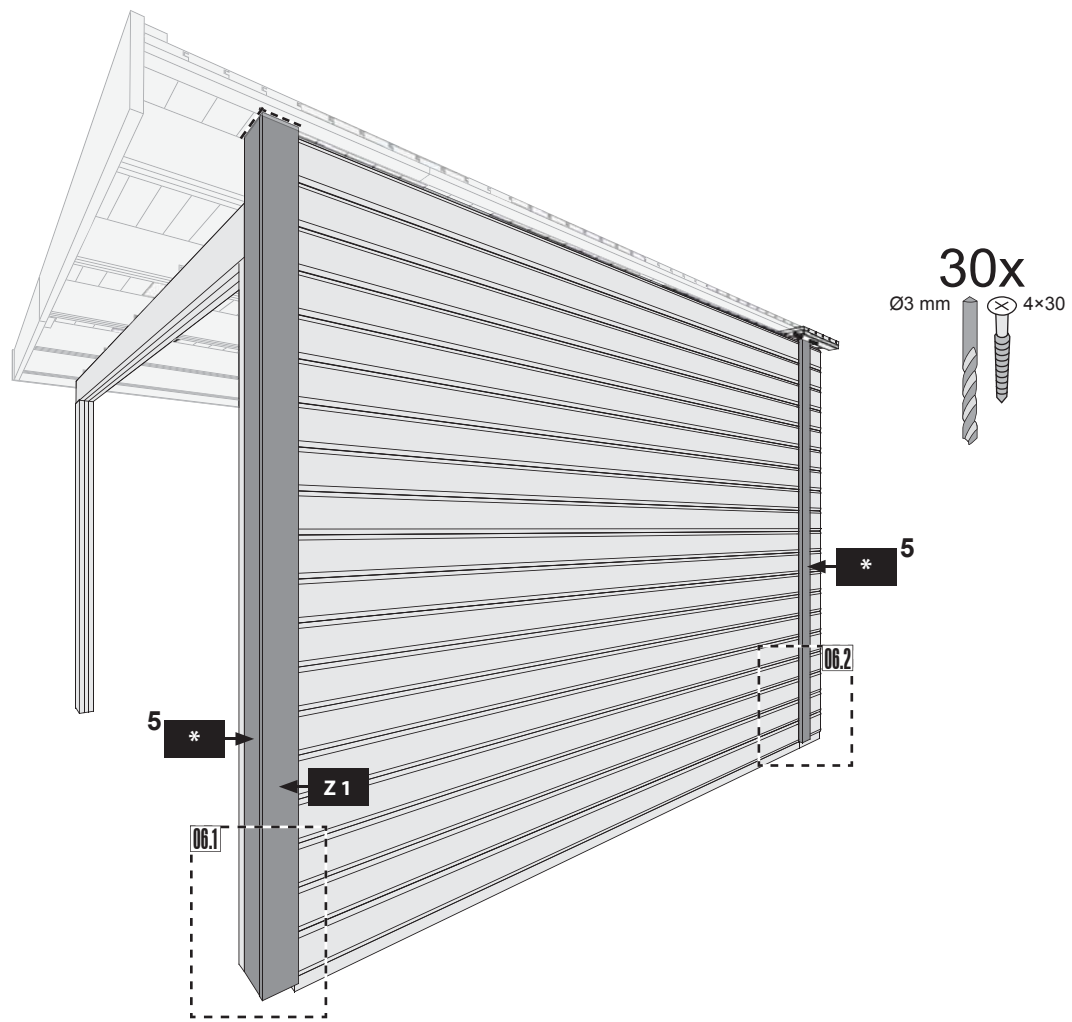

06.1

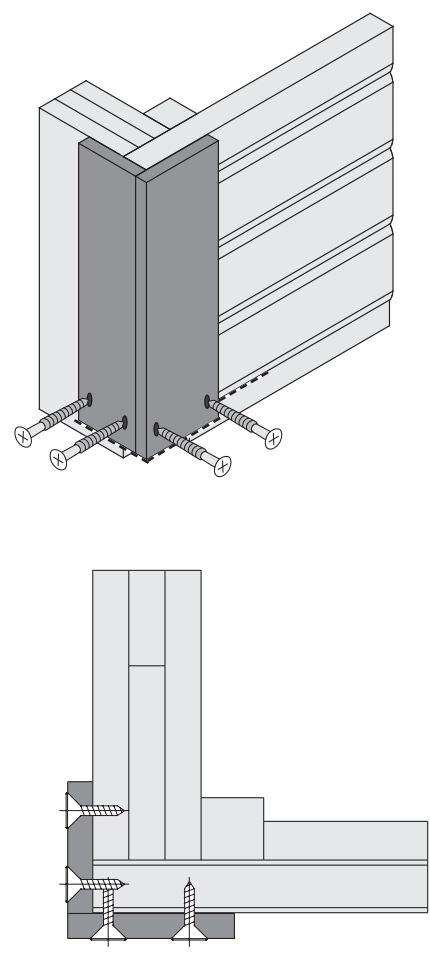

06.2

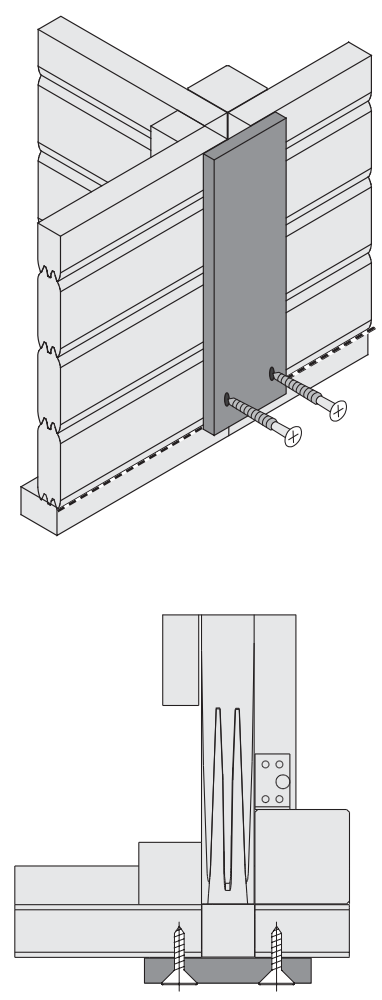

-  Bündig!
-  Flush!
-  Affleurement!
-  Gelijk!
-  I flugt!
-  Aras!
-  Combacia!
-  Stejný !