

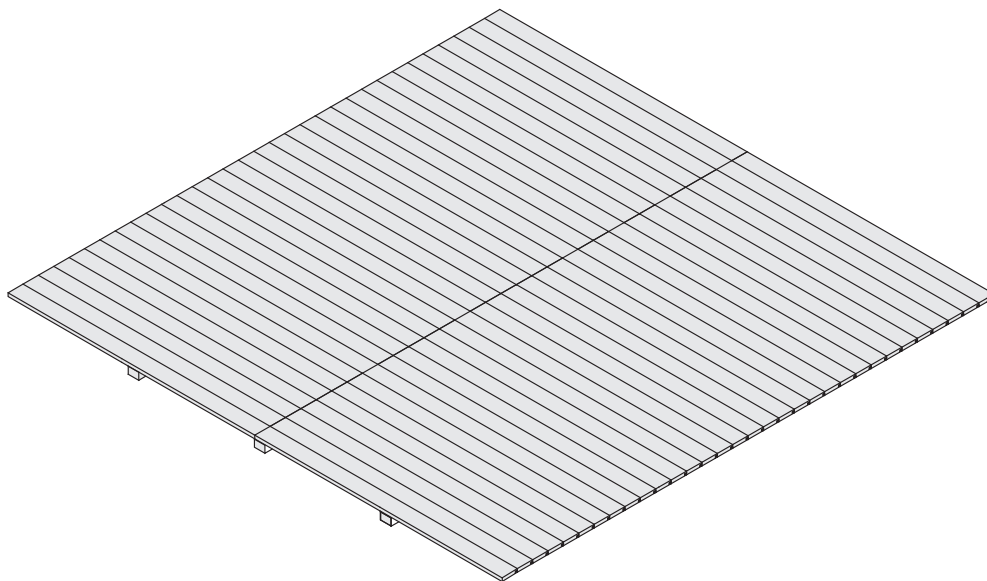



47539





-  **Aufbauanleitung**
-  **Building Instructions**
-  **notice de montage**
-  **montagehandleiding**
-  **Montagevejledning**
-  **Instrucciones de construcción**
-  **Istruzioni per il montaggio**
-  **Montážní návod**
-  **Navodila za sestavljanje**

 Vergleichen Sie zuerst die Material-liste mit Ihrem Paketinhalt! Bitte haben Sie Verständnis, dass Beanstandungen nur im nicht aufgebauten Zustand bearbeitet werden können!

 First compare the list of materials with your package contents! Please understand that complaints can be processed in the non-built status only!

 Commencez par comparer la liste du matériel avec le contenu de votre paquet! Sachez que nous traitons uniquement les réclamations concernant le matériel à l'état non monté!

 Vergelijk eerst de lijst van materialen met de inhoud van uw pakket! Reclamaties kunnen alleen in behandeling worden genomen zolang de onderdelen nog niet zijn gemonteerd!

 Start med at kontrollere materialelisten med indholdet af den leverede pakke! Vi gør venligst opmærksom på at reklamationer kun kan behandles for materialer som ikke er blevet bearbejdet!

 En primer lugar, compare la lista de material con el contenido del paquete. Rogamos entienda que las reclamaciones sólo pueden ser tramitadas antes de montar el objeto!

 Confrontate questa distinta materiali prima con il contenuto del pacchetto! Vi preghiamo di comprendere che eventuali reclami possono essere accolti solo prima del montaggio!

 Nejprve přezkontrolujte obsah balení podle materiálového listu! Mějte pochopení pro to, že případnou reklamaci se můžeme zabývat pouze tehdy, když díly nebudou smontované! Za pomoci tohoto seznamu můžete jednotlivé díly přiřadit k montážnímu návodu.

 Najprej primerajte zoznam materialov z vsebino vašega paketa! Upoštevajte, da lahko pritožbe obravnavamo le v nesestavljenem stanju!

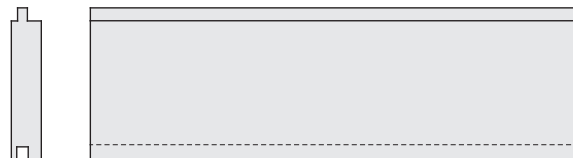

		
3 x B7	825 x 60 x 40 mm	ID 44199
3 x B20	1900 x 60 x 40 mm	ID 43124

		
64 x R1	1415 x 96 x 16 mm	ID 50500

		
12 x	4,5 x 80 mm	ID 9204

		
380 x	2,2 x 50 mm	ID 5621

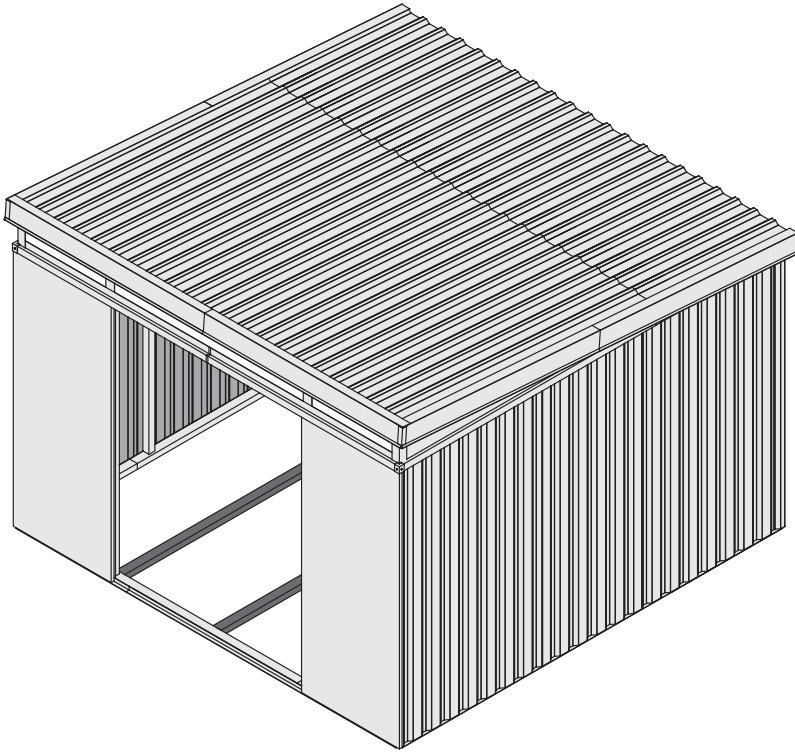

12x
Ø3 mm 4,5x80

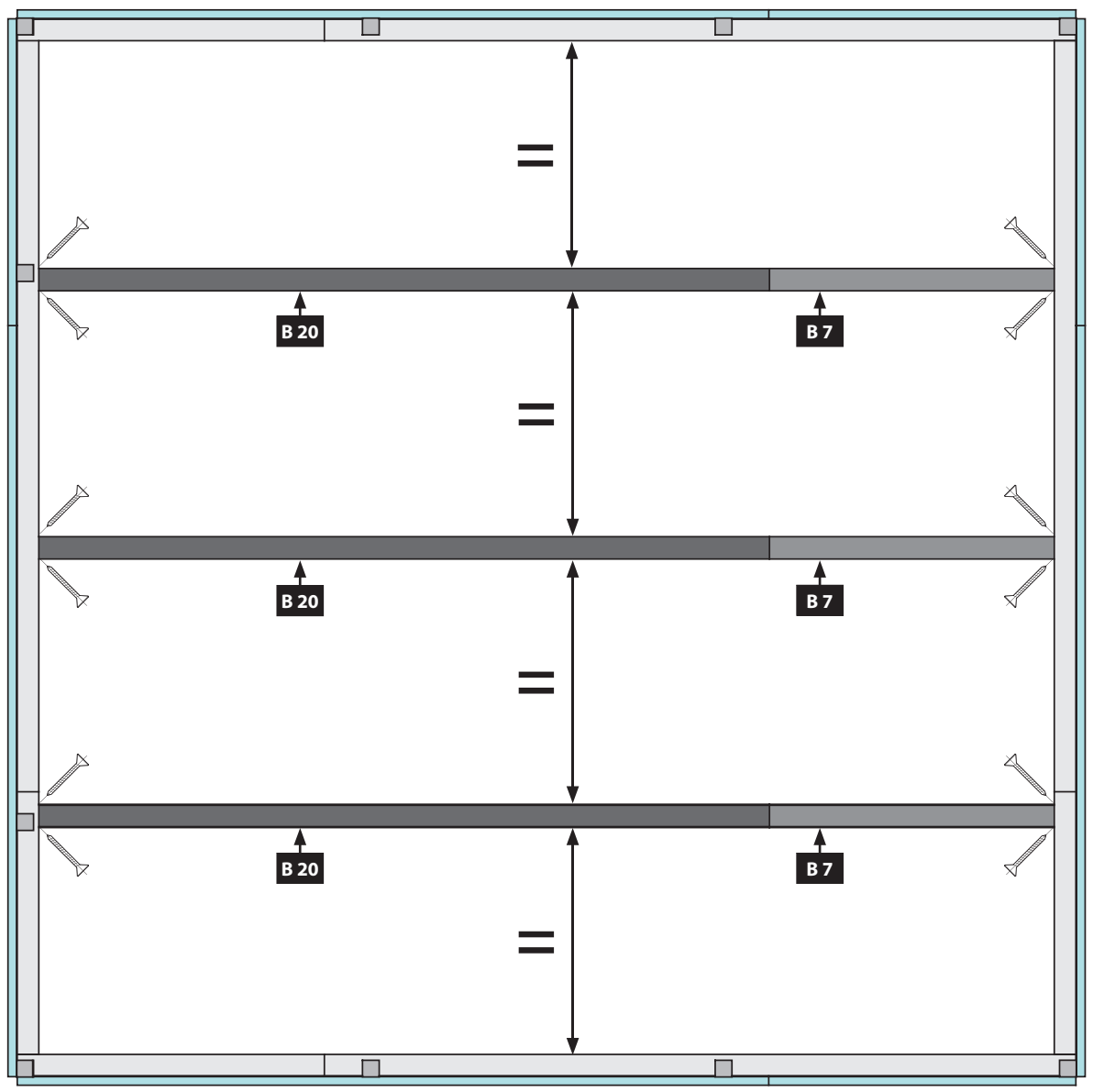
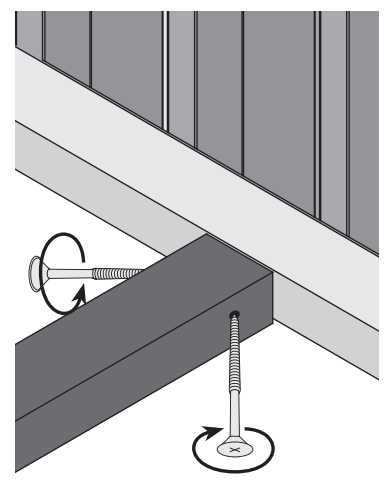

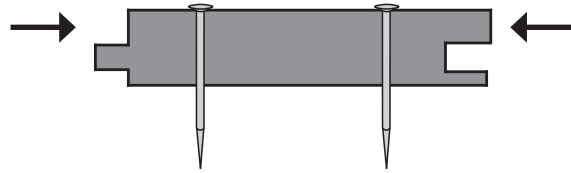

02

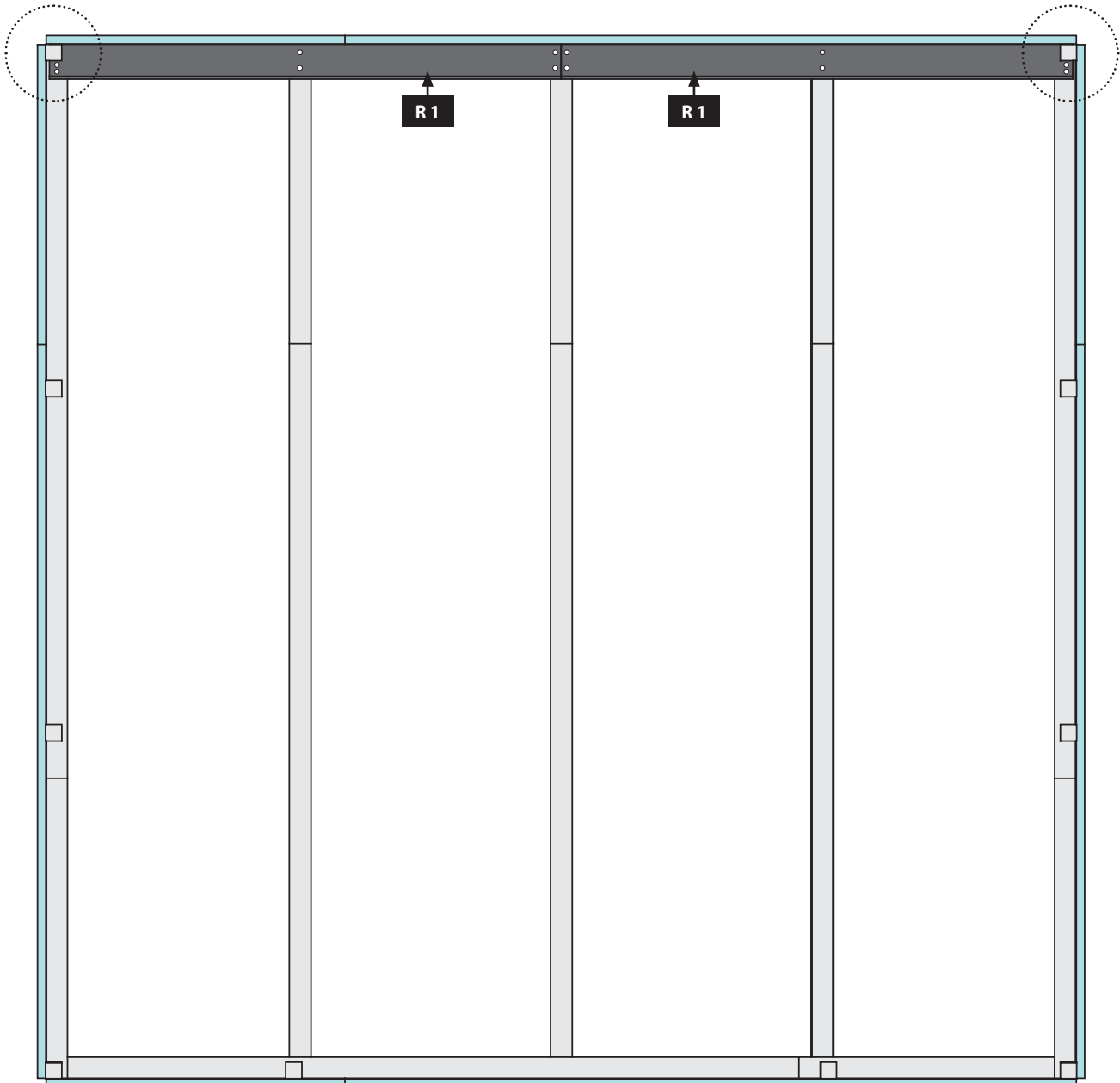
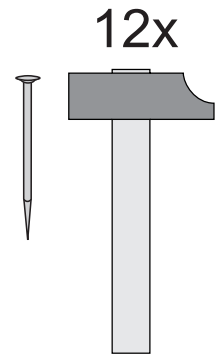
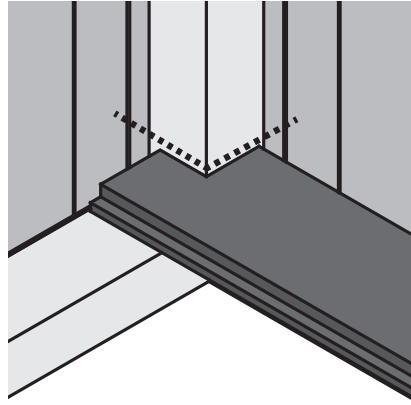
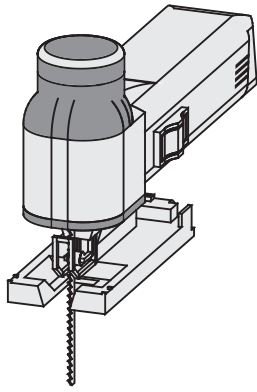

360x

